



Table of Contents

| | | | | | |
|--|----------|----------------|--|--|--|
| | B | | | | |
| Bearing at Top..... | | 4 | | | |
| Bearing on Top..... | | 4 | | | |
| Bearing Replacement Kit..... | | 14 | | | |
| | C | | | | |
| Center Punches | | 14 | | | |
| Concealed Electric Monitoring | | 9, 11 | | | |
| Concealed Electric Through-Wire | | 9, 11 | | | |
| Concealed Electric Through-Wire - Removable | | 9, 11 | | | |
| Concealed Electric Through-Wire and Monitoring | | 10, 11 | | | |
| | D | | | | |
| Door and Frame Dimensioning..... | | 5-8 | | | |
| Concealed | | 6-8 | | | |
| Half Surface | | 5 | | | |
| Full Surface | | 5 | | | |
| Dutch Door Hinges | | 4 | | | |
| | E | | | | |
| Exposed Electric Contacts | | 9, 11 | | | |
| Exposed Electric Switches | | 9, 11 | | | |
| Extra Long Hinges | | 4 | | | |
| | F | | | | |
| Fasteners | | 13 | | | |
| Field Modifications | | 2 | | | |
| Fire Ratings | | 12 | | | |
| | H | | | | |
| Hinges..... | | 15-23 | | | |
| Concealed | | 15, 16, 17, 18 | | | |
| Full Surface..... | | 15, 18, 22 | | | |
| Half Surface | | 15, 17, 20, 23 | | | |
| Hospital Tip | | 17 | | | |
| | L | | | | |
| Length Specifications | | 2 | | | |
| | M | | | | |
| Marking Jigs..... | | 14 | | | |
| Mortar Box | | 10 | | | |
| | P | | | | |
| Polished Cover Channels..... | | 3 | | | |
| | R | | | | |
| Replacement Moldings..... | | 13 | | | |
| | S | | | | |
| Shim Stock | | 14 | | | |
| Shipping Cartons | | 14 | | | |
| Short Hinges..... | | 4 | | | |
| Special Anodizing..... | | 2 | | | |
| Special Cover Channels | | 3 | | | |
| Special Holes | | 4 | | | |
| Special Lengths | | 2 | | | |
| Special Painted Hinges | | 2 | | | |
| Standard Finishes | | 2 | | | |
| Standard Lengths..... | | 2 | | | |
| | T | | | | |
| Tamper Resistant Hinge..... | | 4 | | | |
| Template Hinges | | 2 | | | |
| | V | | | | |
| Von Duprin EPT2 | | 10, 11 | | | |
| Von Duprin EPT10 | | 10, 11 | | | |



Roton Continuous Geared Hinges

Roton Hinge Additions/Modifications

STANDARD LENGTHS

Roton hinges are listed and priced as actual lengths 79" (6'8" opening), 83" (7'0" opening), 85" (7'2" opening), 95" (8'0" opening), and 119" (10'0" opening), for convenience in application to nominal sized doors. Actual length provides for threshold clearance, head clearance and door height allowances for carpeting. Other lengths may be ordered as non-standard items.

SPECIAL LENGTHS

Actual net door heights may be specified at no additional charge. Changes in special length orders or cancellations to such orders will be subject to charges made for work in process.

LENGTH SPECIFICATIONS

If special lengths to match the actual net door heights are required, please indicate this clearly on your order. A special length should be specified from the net door height, not the nominal height of the opening. To order specify: "Actual Length", or "Net Door Height".

Use pricing for the next longer standard length from which the special length can be manufactured. For example, hinges 86 ³/₄" long will be invoiced at the 95" price.

FIELD MODIFICATIONS

While Roton hinges can be field cut, any product modifications may void all warranties. Should in-the-field modifications be required, cut only from bottom of hinge. Do not cut through bearings or screw holes. When cutting electric hinges it is extremely important to clamp both hinge leaves securely to prevent hinge "chatter" which can damage the hinge's internal wiring. Consult the St. Louis sales office before proceeding.

TEMPLATE HINGES

Hager has developed templated hole patterns for Roton hinge models in standard lengths. Drawings are available upon request by contacting Hager Customer Service or accessing the Hager website at www.hagerco.com.

Due to normal variances inherent in the manufacturing process, Roton custom length hinges are deemed by Hager to be non-templated.

STANDARD FINISHES

Roton hinges are available in either satin etched, clear anodized aluminum (similar to US28) or in dark bronze exterior anodized coating.

SPECIAL ANODIZING

Roton can supply unfinished materials to selected finishers for special projects which require unusual colors, but will require that final assembly be completed by Roton. Because of special non-removable metal coatings applied to all hinges during assembly, users are cautioned against attempting to refinish any Roton product.

Roton hinges are available in various special colors including Black, Gold, and other special anodized finishes with fasteners to match. Example, specify "Black Anodized" or "Gold Anodized". All hinges ordered in special colors should be ordered at the same time to guarantee finish uniformity. Add 15% to the Dark Bronze Anodize hinge list price before applying buying group discount.

Other anodized colors by quotation only. Supply color chip for best match.

SPECIAL PAINTED HINGES

Call for quote.

Roton Continuous Geared Hinges



Roton Hinge Additions/Modifications

PAINTED COVER CHANNELS

Painted Roton Cover Channels in Bone White are now offered as a standard stock color option. This is only available on the standard Roton cover channel and should be ordered as Bone White Paint # UC43350. The painted cover channels are priced by adding the following to the hinge list price before applying discounts:

| | List | | | List | List | |
|-----------------------|------|-----|-----|---------|---------|----------|
| | 79" | 83" | 85" | 95" | 119" | |
| Painted Cover Channel | | | | \$61.00 | \$82.00 | \$122.00 |

POLISHED COVER CHANNELS

Any hinge may be ordered with a polished clear cover channel (similar to US26) to complement clear anodized hinge leaves or a polished gold cover channel (similar to US3) to complement satin gold hinge leaves. Add to the hinge list price before applying buying group discount:

| | List | | | List | List | |
|------------------------------|------|-----|-----|---------|----------|----------|
| | 79" | 83" | 85" | 95" | 119" | |
| Polished Clear Cover Channel | | | | \$61.00 | \$82.00 | \$121.00 |
| Polished Gold Cover Channel | | | | \$82.00 | \$102.00 | \$140.00 |

SPECIAL COVER CHANNELS

Special covers for decorative, fluted or rounded effects may be ordered. Availability for hinges with electrical modifications vary. Please consult the St. Louis sales office for confirmation. Add to the hinge list price before applying buying group discount:

| | List | | | List | List | |
|--------------------------------|------|-----|-----|---------|---------|---------|
| | 79" | 83" | 85" | 95" | 119" | |
| Decorative Back Cover Channels | | | | | | |
| Clear Anodized | | | | \$25.00 | \$31.00 | \$40.00 |
| Bronze Anodized | | | | \$50.00 | \$56.00 | \$64.00 |
| Fluted Back Cover Channels | | | | | | |
| Clear Anodized | | | | \$25.00 | \$31.00 | \$40.00 |
| Bronze Anodized | | | | \$50.00 | \$56.00 | \$64.00 |
| Round Back Cover Channels | | | | | | |
| Clear Anodized | | | | \$25.00 | \$31.00 | \$40.00 |
| Bronze Anodized | | | | \$50.00 | \$56.00 | \$64.00 |

1/2" wide insert

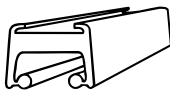

Decorative Back

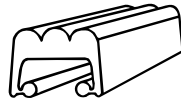

Fluted Back

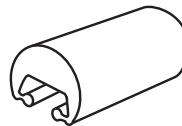

Round Back

| Roton Cover Channel Compatibility | | | | | |
|-----------------------------------|-----------|------------|-------------|-----------------|--|
| Hinge Model | Flat FBCC | Round RBCC | Fluted FLCC | Decorative DBCC | |
| 750-134 | • | • | • | • | |
| 750-138 | • | • | • | • | |
| 780-041 | • | • | | | |
| 780-045 | • | • | | | |
| 780-046 | • | • | | | |
| 780-053 | • | • | | | |
| 780-054 | • | • | | | |
| 780-057 | • | • | | | |
| 780-110 | • | • | • | • | |
| 780-111 | • | • | • | • | |
| 780-112 | • | • | • | • | |
| 780-113 | • | • | • | • | |
| 780-114 | • | • | | | |
| 780-155 | • | • | | | |
| 780-157 | • | | | | |
| 780-208 | • | | • | • | |
| 780-210 | • | • | | | |
| 780-211 | • | • | | | |
| 780-213 | • | • | | | |
| 780-224 | • | • | • | • | |
| 780-226 | • | • | • | • | |
| 780-235 | • | • | • | • | |
| 780-257 | • | | | | |
| 780-259 | • | • | | | |
| 780-300 | • | | | | |



Roton Continuous Geared Hinges

Roton Hinge Additions/Modifications *[continued]*

SPECIAL PRODUCTS

A special product is any product not listed in the price book in regard to length, finish, standard hole preparation or leaf combinations not illustrated. Orders for special products are encouraged, but any changes or cancellations on special orders may result in charges related to work performed and/or material loss. Under no circumstance will non-stock or make-to-order products be accepted for return unless due to Hager error.

Extra Long Hinges - Hinges over 119" are manufactured as two separate lengths with a staggered joint for on-site connection. Hinge segments are taken from standard sizes for best economics in relation to the quantity required. Hanging specifications are required to position the cuts inconspicuously and to finish symmetrical pairs in double door applications. Add to the hinge list price before applying buying group discount:

Splicing Charge \$101.00 List per hinge

Short Hinges - Hinges shorter than 79" will be invoiced at the 79" price. Where two or more short hinges can be obtained from a standard length, pricing is based on the number of standard lengths utilized plus an assembly charge for each hinge. Add to the hinge list price before applying buying group discount:

Assembly Charge \$22.00 List per hinge

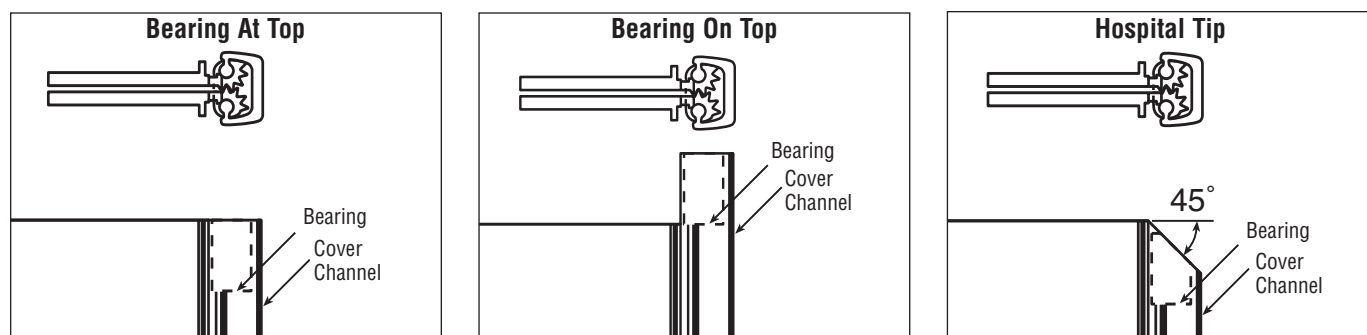

Bearing At Top - This application allows for the bearing to be set at the very top of the cover channel. The cover channel is flush with the top of the geared hinge, preventing any obstructions or debris from being inserted in the top of the channel. Add to the hinge list price before applying buying group discount:

\$41.00 List per hinge

Bearing On Top - This application allows for the bearing to be set at the very top of the extended cover channel. The cover channel is extended the depth of the bearing and projects beyond the top edge of the hinge by the thickness of the bearing. This modification prevents any obstructions or debris from being inserted in the top of the channel. Add to the hinge list price before applying buying group discount:

\$41.00 List per hinge

Hospital Tip - Concealed models only can be prepared with a cover channel tapered at 45° angle at the top of the hinge. These are ideal for use in hospitals and correctional facilities to help provide a clean and safe environment. Please consult the sales office for available concealed models. Add to the hinge list price before applying buying group discount:

\$121.00 List per hinge

Tamper Resistant Hinge - This application is intended for use in hospital psychiatric areas and places of high security. The hinge is prepared with a hospital tip (concealed models only) and every other bearing is supplied with a set screw to lock against the inside of the cover channel for additional security. Add to the hinge list price before applying buying group discount:

\$142.00 List per hinge

Dutch Door Hinges - The frame leaf is furnished as a continuous extrusion and the door leaf is cut to fit the Dutch Door heights specified. Upper and lower door leaves are prepped for extra screws. Hanging, overall net door height, amount of clearance between the top and bottom doors, their individual heights, door, and frame materials should be clearly specified. Add to the hinge list price before applying buying group discount:

\$84.00 List per hinge

Special Holes - Any hinge may be ordered with special hole locations for unusual frame or door conditions. Please provide specifications for each leaf. Add to the hinge list price before applying buying group discount:

Call for quote



Door and Frame Dimensioning

DOOR AND FRAME DIMENSIONING

Half Surface Models

780-045, 780-045HD, 780-046, 780-046HD, 780-053, 780-053HD, 780-054, 780-054HD, 780-155, 780-155HD, 780-211HD, 780-213, 780-213HD, 780-259, 780-259HD, 780-300HD (Leaf thickness clearance not required for 780-300HD)

Designed primarily for work involving new doors and frames, one leaf concealed and one leaf surface mounted. They can also be used on retrofit work where a new door can be ordered to fit an existing frame, the existing door is made of wood and can be reduced in size to accommodate the 1/8" (3.2 mm) leaf thickness, or the frame is to be replaced and can be furnished with an oversized header.

Clearance required as follows:

Single Doors (Square and Beveled Edge)

| | | |
|--|--------------|---------------|
| A. Leaf thickness | 1/8" | 3.2 mm |
| B. Additional allowance for frame irregularities | 1/32" | 0.8 mm |
| C. Lockside clearance for single door | 1/8" | 3.2 mm |
| Total | 9/32" | 7.2 mm |

Pairs of Doors (Square and Beveled Edge)

| | | |
|--|-------------|----------------|
| A. Leaf thickness | 1/8" | 3.2 mm |
| B. Additional allowance for frame irregularities | 1/32" | 0.8 mm |
| C. Edge to edge clearance (recommended) | 3/16" | 4.8 mm |
| D. Second allowance for frame irregularities | 1/32" | 0.8 mm |
| E. Second leaf thickness | 1/8" | 3.2 mm |
| Total | 1/2" | 12.8 mm |

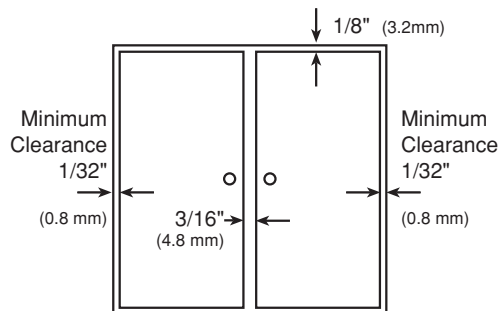
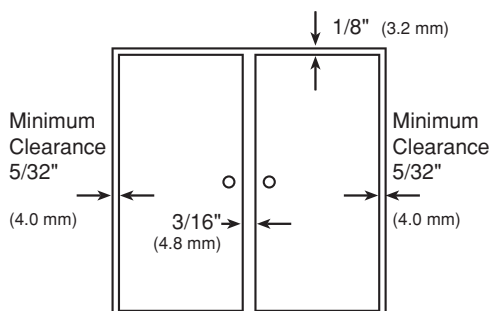
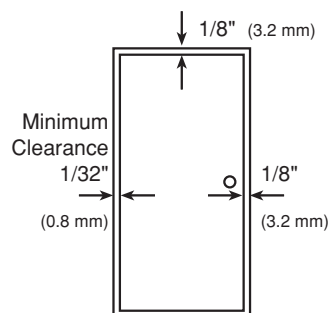
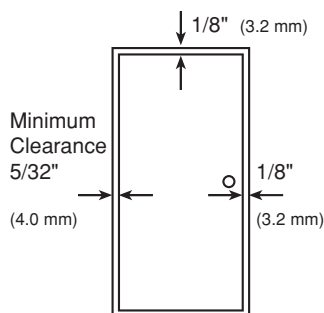

DOOR AND FRAME DIMENSIONING

Full Surface Models

780-057, 780-057HD, 780-157, 780-157HD, 780-210, 780-210HD, 780-257HD

The above models are designed for retrofit applications and require no special dimensioning. Full Surface models are designed to be mounted to the exposed surface of the door and frame. No additional clearance is required except for door and frame painting.

Clearance required as follows:

Single Doors (Square and Beveled Edge)

| | | |
|--|--------------|---------------|
| A. Additional allowance for frame irregularities | 1/32" | 0.8 mm |
| B. Lockside clearance for single door | 1/8" | 3.2 mm |
| Total | 5/32" | 4.0 mm |

Pairs of Doors (Square and Beveled Edge)

| | | |
|--|-------------|---------------|
| A. Additional allowance for frame irregularities | 1/32" | 0.8 mm |
| B. Edge to edge clearance (recommended) | 3/16" | 4.8 mm |
| C. Second allowance for frame irregularities | 1/32" | 0.8 mm |
| Total | 1/4" | 6.4 mm |



Roton Continuous Geared Hinges

Door and Frame Dimensioning

DOOR AND FRAME DIMENSIONING

Concealed Models

750-134, 750-138, 780-110, 780-110HD, 780-111, 780-111HD, 780-111LL, 780-112, 780-112HD, 780-112LL, 780-224, 780-224HD, 780-224LL, 780-226, 780-226HD, 780-226LL, 780-235HD. **The following are not recommended for doors with beveled edged applications – 780-041, 780-041HD and 780-041LL.**

Designed primarily for work involving new doors and frames, these models have parallel, fully concealed leaves. They can also be used on retrofit work where a new door can be ordered to fit an existing frame, the existing door is made of wood and can be reduced in size to accommodate the $\frac{5}{16}$ " (7.9 mm) hinge thickness, or the frame is to be replaced and can be furnished with an oversized header.

Clearance required as follows:

Single Doors (Square Edged)

| | | |
|--|-------------------|---------|
| A. Hinge thickness* | $\frac{5}{16}$ " | 7.9 mm |
| B. Additional allowance for frame irregularities | $\frac{1}{32}$ " | 0.8 mm |
| C. Lockside clearance for single door | $\frac{1}{8}$ " | 3.2 mm |
| Total | $\frac{15}{32}$ " | 11.9 mm |

Single Doors (Beveled Edged)

| | | |
|--|------------------|---------|
| A. Hinge thickness* | $\frac{5}{16}$ " | 7.9 mm |
| B. Additional allowance for frame irregularities | $\frac{1}{32}$ " | 0.8 mm |
| C. Lockside clearance for single door | $\frac{1}{8}$ " | 3.2 mm |
| D. Allowance for beveled edge | $\frac{1}{32}$ " | 0.8 mm |
| Total | $\frac{1}{2}$ " | 12.7 mm |

Pairs of Doors (Square Edged)

| | | |
|--|------------------|---------|
| A. Hinge thickness* | $\frac{5}{16}$ " | 7.9 mm |
| B. Additional allowance for frame irregularities | $\frac{1}{32}$ " | 0.8 mm |
| C. Edge to edge clearance (recommended) | $\frac{3}{16}$ " | 4.8 mm |
| D. Second allowance for frame irregularities | $\frac{1}{32}$ " | 0.8 mm |
| E. Second hinge thickness* | $\frac{5}{16}$ " | 7.9 mm |
| Total | $\frac{7}{8}$ " | 22.2 mm |

Pairs of Doors (Beveled Edged)

| | | |
|--|-------------------|---------|
| A. Hinge thickness* | $\frac{5}{16}$ " | 7.9 mm |
| B. Allowance for beveled edge | $\frac{1}{32}$ " | 0.8 mm |
| C. Additional allowance for frame irregularities | $\frac{1}{32}$ " | 0.8 mm |
| D. Edge to edge clearance (recommended) | $\frac{3}{16}$ " | 4.8 mm |
| E. Second allowance for frame irregularities | $\frac{1}{32}$ " | 0.8 mm |
| F. Second allowance for beveled edge | $\frac{1}{32}$ " | 0.8 mm |
| G. Second hinge thickness* | $\frac{5}{16}$ " | 7.9 mm |
| Total | $\frac{15}{16}$ " | 23.8 mm |

* See exceptions

Concealed Models (cont.)

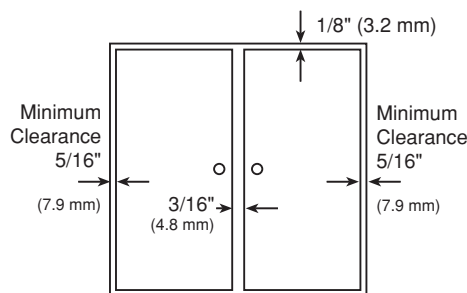
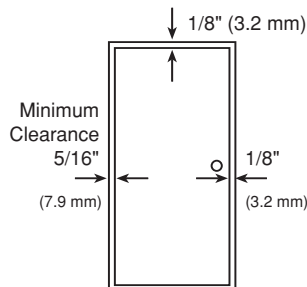

Roton Continuous Geared Hinges



Door and Frame Dimensioning

DOOR AND FRAME DIMENSIONING

Concealed Model Exceptions

780-113, 780-113HD

Single Doors (Square Edged)

| | | |
|--|-------------------|---------|
| A. Hinge thickness | $\frac{13}{16}$ " | 20.6 mm |
| B. Additional allowance for frame irregularities | $\frac{1}{32}$ " | 0.8 mm |
| C. Lockside clearance for single door | $\frac{1}{8}$ " | 3.2 mm |
| Total | $\frac{31}{32}$ " | 24.6 mm |

Single Doors (Beveled Edged)

| | | |
|--|-------------------|---------|
| A. Hinge thickness | $\frac{13}{16}$ " | 20.6 mm |
| B. Additional allowance for frame irregularities | $\frac{1}{32}$ " | 0.8 mm |
| C. Lockside clearance for single door | $\frac{1}{8}$ " | 3.2 mm |
| D. Allowance for beveled edge | $\frac{1}{32}$ " | 0.8 mm |
| Total | 1" | 12.8 mm |

Pairs of Doors (Square Edged)

| | | |
|--|-------------------|---------|
| A. Hinge thickness | $\frac{13}{16}$ " | 20.6 mm |
| B. Additional allowance for frame irregularities | $\frac{1}{32}$ " | 0.8 mm |
| C. Edge to edge clearance (recommended) | $\frac{3}{16}$ " | 4.8 mm |
| D. Second allowance for frame irregularities | $\frac{1}{32}$ " | 0.8 mm |
| E. Second hinge thickness | $\frac{13}{16}$ " | 0.6 mm |
| Total | $\frac{17}{8}$ " | 47.6 mm |

Pairs of Doors (Beveled Edged)

| | | |
|--|--------------------|---------|
| A. Hinge thickness | $\frac{13}{16}$ " | 20.6 mm |
| B. Allowance for beveled edge | $\frac{1}{32}$ " | 0.8 mm |
| C. Additional allowance for frame irregularities | $\frac{1}{32}$ " | 0.8 mm |
| D. Edge to edge clearance (recommended) | $\frac{3}{16}$ " | 4.8 mm |
| E. Second allowance for frame irregularities | $\frac{1}{32}$ " | 0.8 mm |
| F. Second allowance for beveled edge | $\frac{1}{32}$ " | 0.8 mm |
| G. Second hinge thickness | $\frac{13}{16}$ " | 20.6 mm |
| Total | $\frac{115}{16}$ " | 49.2 mm |

Concealed Model Exceptions (continued)

780-114, 780-114HD

Single Doors (Square Edged)

| | | |
|--|-------------------|---------|
| A. Hinge thickness | $\frac{13}{16}$ " | 20.6 mm |
| B. Additional allowance for frame irregularities | $\frac{1}{32}$ " | 0.8 mm |
| C. Lockside clearance for single door | $\frac{1}{8}$ " | 3.2 mm |
| Total | $\frac{31}{32}$ " | 24.6 mm |

Single Doors (Beveled Edged)

| | | |
|--|-------------------|---------|
| A. Hinge thickness | $\frac{13}{16}$ " | 20.6 mm |
| B. Additional allowance for frame irregularities | $\frac{1}{32}$ " | 0.8 mm |
| C. Lockside clearance for single door | $\frac{1}{8}$ " | 3.2 mm |
| D. Allowance for beveled edge | $\frac{1}{32}$ " | 0.8 mm |
| Total | 1" | 12.8 mm |

Pairs of Doors (Square Edged)

| | | |
|--|-------------------|---------|
| A. Hinge thickness | $\frac{13}{16}$ " | 20.6 mm |
| B. Additional allowance for frame irregularities | $\frac{1}{32}$ " | 0.8 mm |
| C. Edge to edge clearance (recommended) | $\frac{3}{16}$ " | 4.8 mm |
| D. Second allowance for frame irregularities | $\frac{1}{32}$ " | 0.8 mm |
| E. Second hinge thickness | $\frac{13}{16}$ " | 0.6 mm |
| Total | $\frac{17}{8}$ " | 47.6 mm |

Pairs of Doors (Beveled Edged)

| | | |
|--|--------------------|---------|
| A. Hinge thickness | $\frac{13}{16}$ " | 20.6 mm |
| B. Allowance for beveled edge | $\frac{1}{32}$ " | 0.8 mm |
| C. Additional allowance for frame irregularities | $\frac{1}{32}$ " | 0.8 mm |
| D. Edge to edge clearance (recommended) | $\frac{3}{16}$ " | 4.8 mm |
| E. Second allowance for frame irregularities | $\frac{1}{32}$ " | 0.8 mm |
| F. Second allowance for beveled edge | $\frac{1}{32}$ " | 0.8 mm |
| G. Second hinge thickness | $\frac{13}{16}$ " | 20.6 mm |
| Total | $\frac{115}{16}$ " | 49.2 mm |

Single Doors (Square Edged)

| | | |
|--|-------------------|---------|
| A. Hinge thickness | $\frac{15}{16}$ " | 23.8 mm |
| B. Additional allowance for frame irregularities | $\frac{1}{32}$ " | 0.8 mm |
| C. Lockside clearance for single door | $\frac{1}{8}$ " | 3.2 mm |
| Total | $\frac{13}{32}$ " | 27.8 mm |

Pair of Doors (Square Edged)

| | | |
|--|-------------------|---------|
| A. Hinge thickness | $\frac{15}{16}$ " | 23.8 mm |
| B. Additional allowance for frame irregularities | $\frac{1}{32}$ " | 0.8 mm |
| C. Edge to edge clearance (recommended) | $\frac{3}{16}$ " | 4.8 mm |
| D. Second allowance for frame irregularities | $\frac{1}{32}$ " | 0.8 mm |
| E. Second hinge thickness | $\frac{15}{16}$ " | 23.8 mm |
| Total | $\frac{21}{8}$ " | 54.0 mm |



Roton Continuous Geared Hinges

Door and Frame Dimensioning

Concealed Model Exceptions (continued)

780-208, 780-208HD

Single Doors (Square Edged)

| | | |
|--|---------------|----------------|
| A. Hinge thickness | 1/2" | 2.7 mm |
| B. Additional allowance for frame irregularities | 1/32" | 0.8 mm |
| C. Lockside clearance for single door | 1/8" | 3.2 mm |
| Total | 21/32" | 16.7 mm |

Single Doors (Beveled Edged)

| | | |
|--|---------------|----------------|
| A. Hinge thickness | 1/2" | 12.7 mm |
| B. Additional allowance for frame irregularities | 1/32" | 0.8 mm |
| C. Lockside clearance for single door | 1/8" | 3.2 mm |
| D. Allowance for beveled edge | 1/32" | 0.8 mm |
| Total | 11/16" | 17.5 mm |

Pair of Doors (Square Edged)

| | | |
|--|--------------|----------------|
| A. Hinge thickness | 1/2" | 2.7 mm |
| B. Additional allowance for frame irregularities | 1/32" | 0.8 mm |
| C. Edge to edge clearance (recommended) | 3/16" | 4.8 mm |
| D. Second allowance for frame irregularities | 1/32" | 0.8 mm |
| E. Second hinge thickness | 1/2" | 12.7 mm |
| Total | 11/4" | 31.8 mm |

Pair of Doors (Beveled Edged)

| | | |
|--|---------------|----------------|
| A. Hinge thickness | 1/2" | 12.7 mm |
| B. Allowance for beveled edge | 1/32" | 0.8 mm |
| C. Additional allowance for frame irregularities | 1/32" | 0.8 mm |
| D. Edge to edge clearance (recommended) | 3/16" | 4.8 mm |
| E. Second allowance for frame irregularities | 1/32" | 0.8 mm |
| F. Second allowance for beveled edge | 1/32" | 0.8 mm |
| G. Second hinge thickness | 1/2" | 2.7 mm |
| Total | 15/16" | 33.3 mm |

Concealed Model Exceptions (continued)

1200-600XHD, 1200-650XHD

Single Doors (Square Edged)

| | | |
|--|-------------|----------------|
| A. Hinge thickness | 15/32" | 11.9 mm |
| B. Additional allowance for frame irregularities | 1/32" | 0.8 mm |
| C. Lockside clearance | 1/8" | 3.2 mm |
| Total | 5/8" | 15.9 mm |

Single Doors (Beveled Edged)

| | | |
|--|---------------|----------------|
| A. Hinge thickness | 15/32" | 11.9 mm |
| B. Additional allowance for frame irregularities | 1/32" | 0.8 mm |
| C. Lockside clearance for single door | 1/8" | 3.2 mm |
| D. Allowance for beveled edge | 1/32" | 0.8 mm |
| Total | 21/32" | 16.7 mm |

Pair of Doors (Square Edged)

| | | |
|--|---------------|----------------|
| A. Hinge thickness | 15/32" | 11.9 mm |
| B. Additional allowance for frame irregularities | 1/32" | 0.8 mm |
| C. Edge to edge clearance (recommended) | 3/16" | 4.8 mm |
| D. Second allowance for frame irregularities | 1/32" | 0.8 mm |
| E. Second hinge thickness | 15/32" | 11.9 mm |
| Total | 13/16" | 30.2 mm |

Pair of Doors (Beveled Edged)

| | | |
|--|--------------|----------------|
| A. Hinge thickness | 15/32" | 11.9 mm |
| B. Allowance for beveled edge | 1/32" | 0.8 mm |
| C. Additional allowance for frame irregularities | 1/32" | 0.8 mm |
| D. Edge to edge clearance (recommended) | 3/16" | 4.8 mm |
| E. Second allowance for beveled edge | 1/32" | 0.8 mm |
| F. Second hinge thickness | 15/32" | 11.9 mm |
| Total | 11/4" | 31.8 mm |

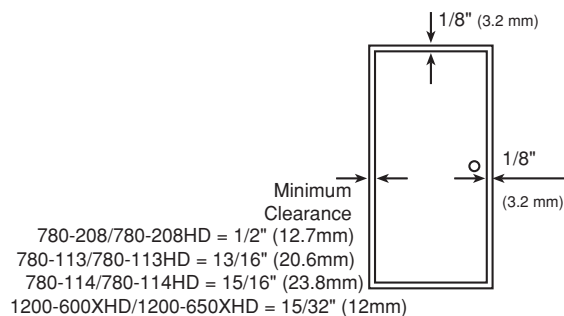
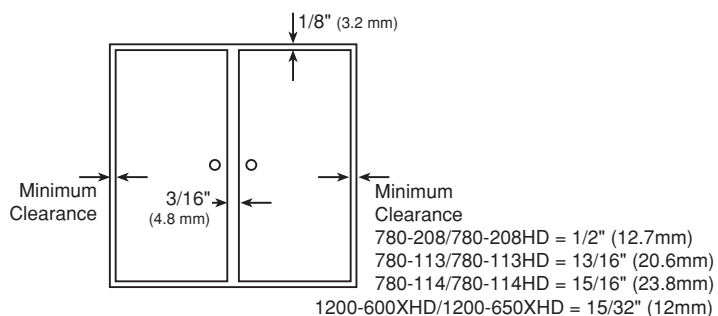



Electrical Modifications

ELECTRIC HINGE MODIFICATIONS

Exposed Electric Contacts:

- Transfers power to door in closed position
- To order, use symbol “E” plus the number of contacts required as a suffix
- Must have at least two (2) contacts to transfer power
- Example: 780-112HD 85" Clear E4
- Specify handing and the dimension from the top edge of the door to the centerline of the electric contact location
- Templates regarding location of contacts available upon request
- Add to the hinge list price before applying buying group discount: \$92.50 List per contact

Exposed Electric Switches:

- Miniature push button switch is incorporated in the hinge frame leaf to monitor position of the door
- Three 12" wire leads
- To order, use symbol “E1S” as a suffix
- Each monitoring hinge only needs one E1S switch
- Example: 780-112HD 85" Clear E1S
- Specify handing and the dimension from the top edge of the door to the centerline of the electric switch location
- Templates regarding location of contact switch available upon request
- Add to the hinge list price before applying buying group discount: \$92.50 List per switch

Concealed Electric Through-Wire:

- Transfers power discreetly from building to door hardware
- Four, Six, Eight or Ten wire continuous electric conductors
- To order, use symbol “ETW” plus the number of wire leads, 12" per side required as a suffix
- Example: 780-112HD 85" Clear ETW - 4
- Specify handing and the dimension from the top edge of the door to the centerline of electric through-wire location
- Templates regarding location of through-wires available upon request
- Add to the hinge list price before applying buying group discount:

| <u>Electrical Preparation</u> | <u>List</u> |
|-------------------------------|-------------|
| ETW-4 | \$265.00 |
| ETW-6 | \$308.00 |
| ETW-8 | \$345.00 |
| ETW-10 | \$393.00 |

Removable Electric Through-Wire:

- Transfers power discreetly from building to door hardware
- 4" removable ETW 10 wire module can easily be removed for adjustment or service
- To order, use symbol “RETW”
- Example: 780-112HD 85" Clear RETW
- Available on heavy duty models only
- Specify handing and the dimension from the top edge of the door to the centerline of electric through-wire location
- Templates regarding location of module available upon request
- Prep locations are limited. Please call for locations.
- Add to the hinge list price before applying buying group discount: \$654.00 List
\$218.50 List - Module only

Concealed Electric Monitoring:

- Miniature switch is incorporated into the frame leaf
- Three 12" wire leads
- To order, use symbol “EMN”, as a suffix
- Example: 780-224HD 119" Bronze EMN
- Specify handing and the dimension from the top edge of the door to the centerline of electric monitoring location
- Templates regarding location of monitoring switch available upon request
- Add to the hinge list price before applying buying group discount: \$265.00 List per hinge



Roton Continuous Geared Hinges

Electrical Modifications

Concealed Electric Through-Wire and Monitoring:

- This combines the continuous electric conductors and the miniature switch to provide both power transfer and monitoring
- Four, Six, Eight or Ten continuous electric conductors
- Miniature switch is incorporated into the frame leaf
- To order, use symbol "ETM" plus the number of wires required as a suffix
- Example: 780-224LL 85" Bronze ETM - 4
- Specify handing and the dimension from the top edge of the door to the centerline of each electric modification location
- Templates regarding location of monitoring switch, available upon request
- Add to the hinge list price before applying buying group discount:

| <u>Electric Preparation</u> | <u>List</u> |
|-----------------------------|-------------|
| ETM-4 | \$529.00 |
| ETM-6 | \$577.00 |
| ETM-8 | \$614.00 |
| ETM-10 | \$654.00 |

- Standard wire leads are 12" per side
- Additional wire leads are available
- Add to the hinge list price before applying buying group discount:

| <u>Electric Preparation</u> | <u>List</u> |
|-----------------------------|------------------|
| 4-wire hinge | \$9.00 per foot |
| 6-wire hinge | \$13.25 per foot |
| 8-wire hinge | \$16.50 per foot |

Von Duprin EPT 2 or EPT 10 Electric Power Transfer Preparation

- Hinge leaf cutout to accommodate power transfer device
- Specify handing and the dimension from the top edge of the door to the centerline of the power transfer location
- Special Electric Modifications and EPT locations may require additional charges if screw holes have to be moved. Contact Hager Customer Service for charges. Please feel free to contact the Hager technical team for further information pertaining to electric modifications.
- Add to the hinge list price before applying buying group discount:
\$103.00 List per hinge - Concealed Leaf
\$62.00 List per hinge - Half Surface

Mortar Box - 430

- Serves as a mortar shield
- Overall dimensions: 9" (229 mm) length with tabs, 7" (178 mm) inside,
1³/₄" x 1³/₄" (45 x 45 mm) inside dimension
- Galvanized steel 0.040" (1 mm)
- Top and bottom knockouts for standard conduit fittings
- Add to the hinge list price before applying buying group discount:
\$34.25 List per each box

Roton Continuous Geared Hinges



Electrical Modifications

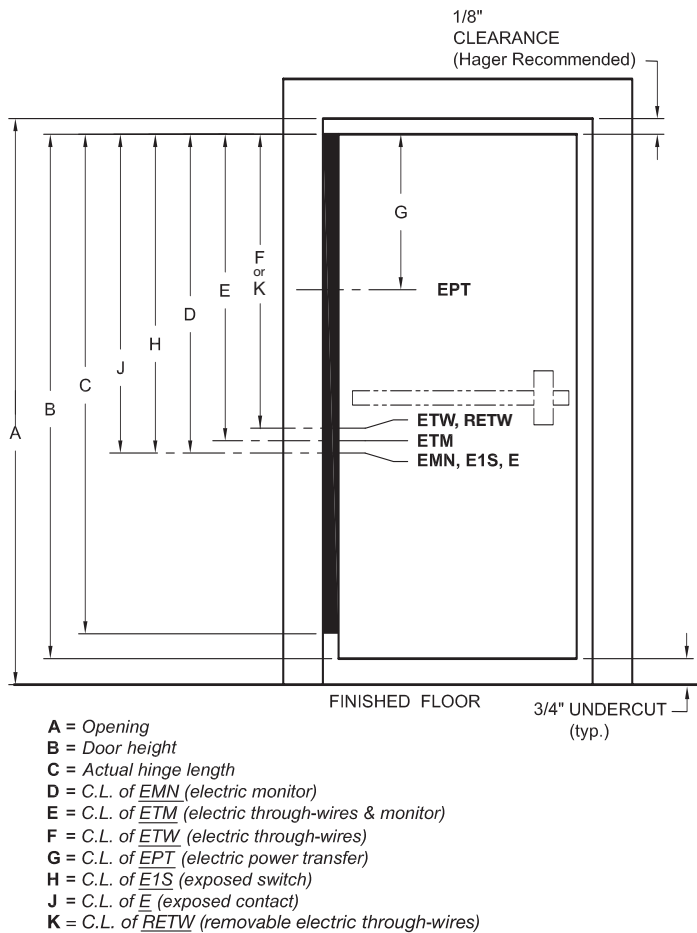

ELECTRIC HINGE MODIFICATIONS

| | A | B | C | D | E | F | G | H | J | K |
|--------|------|----------|-----------|---------|---------|---------|----------|---------|---------|----------|
| 79 SD | 80" | 79 1/8" | 78 11/16" | 42 1/2" | 41 1/4" | 40" | 24 1/2" | 42 1/2" | 42 1/2" | - |
| 79 HD | 80" | 79 1/8" | 78 11/16" | 42 1/2" | 40 5/8" | 38 3/4" | 24 1/2" | 42 1/2" | 42 1/2" | 41 7/8" |
| 83 SD | 84" | 83 1/8" | 83" | 46 1/2" | 44 5/8" | 42 3/4" | 28 7/16" | 46 1/2" | 46 1/2" | - |
| 83 HD | 84" | 83 1/8" | 83" | 46 1/2" | 45 1/4" | 44" | 28 7/16" | 46 1/2" | 46 1/2" | 44 1/16" |
| 85 SD | 86" | 85 1/8" | 85" | 48 1/2" | 47 1/4" | 46" | 30 7/16" | 48 1/2" | 48 1/2" | - |
| 85 HD | 86" | 85 1/8" | 85" | 48 1/2" | 46 5/8" | 44 3/4" | 30 7/16" | 48 1/2" | 48 1/2" | 45 1/16" |
| 95 SD | 96" | 95 1/8" | 95 1/16" | 59 3/4" | 57 7/8" | 56" | 40 1/2" | 59 3/4" | 59 3/4" | - |
| 95 HD | 96" | 95 1/8" | 95 1/16" | 59 3/4" | 57 7/8" | 56" | 40 1/2" | 59 3/4" | 59 3/4" | 56 1/2" |
| 119 SD | 120" | 119 1/8" | 119" | 83 3/4" | 81 7/8" | 80" | 64 3/8" | 83 3/4" | 83 3/4" | - |
| 119 HD | 120" | 119 1/8" | 119" | 83 3/4" | 81 7/8" | 80" | 64 3/8" | 83 3/4" | 83 3/4" | 80" |

| PART NUMBER | VON DUPRIN EPT 2 OR EPT 10 POWER TRANSFER PREPARATION | EXPOSED ELECTRIC CONTACTS | EXPOSED ELECTRIC SWITCHES | CONCEALED ELECTRIC THROUGH-WIRE | CONCEALED ELECTRIC MONITORING | CONCEALED ELECTRIC THROUGH-WIRE AND MONITORING | REMOVABLE ELECTRIC THROUGH-WIRE |
|-------------|---|---------------------------|---------------------------|---------------------------------|-------------------------------|--|---------------------------------|
| 750-134 | | | | | | | |
| 750-138 | | | | | | | |
| 780-041 | | | | | | | |
| 780-041HD | | | | | | | |
| 780-041LL | | | | | | | |
| 780-045 | • | | | | | | |
| 780-045HD | • | | | | | | |
| 780-046 | • | | | | | | |
| 780-046HD | • | | | | | | |
| 780-053 | • | | | | | | |
| 780-053HD | • | | | | | | |
| 780-054 | • | | | | | | |
| 780-054HD | • | | | | | | |
| 780-110 | • | | • | • | | | |
| 780-110HD | • | | • | • | | | |
| 780-111 | • | • | • | • | • | • | |
| 780-111HD | • | • | • | • | • | • | • |
| 780-111LL | • | • | • | • | • | • | |
| 780-112 | • | • | • | • | • | • | |
| 780-112HD | • | • | • | • | • | • | • |
| 780-112LL | • | • | • | • | • | • | |
| 780-155 | | | | | | | |
| 780-155HD | | | | | | | |
| 780-211HD | | | | | | | |
| 780-224 | • | • | • | • | • | • | |
| 780-224HD | • | • | • | • | • | • | • |
| 780-224LL | • | • | • | • | • | • | |
| 780-226 | • | • | • | • | • | • | |
| 780-226HD | • | • | • | • | • | • | • |
| 780-226LL | • | • | • | • | • | • | |
| 780-235HD | | • | • | • | • | | |

For ease of ordering, Hager has established standard locations for power transfer cutouts. All standard location dimensions are referenced from the top edge of the door to the centerline of the power transfer cutout. Please specify handing.



1/1/09

800-325-9995
www.hagerco.com



Roton Continuous Geared Hinges

Fire Ratings—Underwriters Laboratory Fire Rating File #R14627

FIRE RATINGS

Underwriters Laboratories, Inc.
Fire Rating/File #R14627



780 Series Roton Continuous Geared Hinges **with** stainless steel studs are approved for use on 4'x10' metal or wood swing type door

780 Series Roton Continuous Geared Hinges **without** stainless steel studs are approved for use on 4'x8' single swing metal doors and 4'x10' single swing wood doors

- Hollow metal, tin-clad, sheet-metal and steel covered composite type rated up to and including 3 hours
- Wood composite doors rated up to and including 1½ hours
- Wood core doors rated up to 20 minutes without hose stream, non-studded
- 780 Series Roton Continuous Geared Hinges meet requirements for positive pressure UL10C, UL10B and UBC7-2 Part 1
- 780 Series Roton Continuous Geared Hinges are approved for ANSI A156.26 Grade 1 for 150 lb. doors
- 780 Series Roton heavy duty hinges are approved for ANSI A156.26 Grade 1 for 300 lb. doors
- 780-112 Roton Continuous Geared Hinge is Warnock-Hersey certified in accordance with ANSI A250.13 2003 Standard Severe Windstorm Resistant Components

| UL10C Fire Rated Roton | Fully Concealed | Half Surface | Full Surface |
|---|-----------------|--------------|--------------|
| 20 Minute Fire Rated Wood Door x Fire Rated Hollow Metal Frame | UL — FF | UL — FF | UL — FF |
| 20 Minute Fire Rated Metal Door x Fire Rated Hollow Metal Frame | UL — FF | UL — FF | UL — FF |
| 30 Minute Fire Rated Wood Door x Fire Rated Hollow Metal Frame | UL — Stud | UL — Stud | UL — Stud |
| 30 Minute Fire Rated Metal Door x Fire Rated Hollow Metal Frame | UL — FF | UL — FF | UL — FF |
| 45 Minute Fire Rated Wood Door x Fire Rated Hollow Metal Frame | UL — Stud | UL — Stud | UL — Stud |
| 45 Minute Fire Rated Metal Door x Fire Rated Hollow Metal Frame | UL — FF | UL — FF | UL — FF |
| 90 Minute Fire Rated Wood Door x Fire Rated Hollow Metal Frame | UL — Stud | UL — Stud | UL — Stud |
| 90 Minute Fire Rated Metal Door x Fire Rated Hollow Metal Frame | UL — FF | UL — FF | UL — FF |
| 3 Hour Fire Rated Metal Door x Fire Rated Hollow Metal Frame | UL — Stud | UL — Stud | UL — Stud |

Models for which studs are not required (UL-FF) are no extra charge. Please specify if UL stamp is required.

*Models for which studs are required have an extra charge. 4 studs required for UL stud hinges. Add to the hinge list price before applying buying group discount - \$57.00.

Example: 780-112LL 83" Clear U/L — FF
Example: 780-211HD 95" DB U/L — Stud

Concealed — These models are concealed between the frame and the hinge edge of the door.

Models available: 780-041, 780-041HD, 780-041LL, 780-110, 780-110HD, 780-111, 780-111HD, 780-111LL, 780-112, 780-112HD, 780-112LL, 780-224, 780-224HD, 780-224LL, 780-226, 780-226HD, 780-226LL, 780-235HD

Half Surface — These models have the frame leaf concealed between the frame and the edge of the door. The door leaf is mounted to the door with thru-bolts or screws.

Models available: 780-045, 780-045HD, 780-046, 780-046HD, 780-053, 780-053HD, 780-054, 780-054HD, 780-211HD, 780-300HD

Full Surface — These models have the frame leaf mounted to the face of the frame and the face of the door. The door leaf is mounted to the face of the door with thru-bolts.

Models available: 780-057, 780-057HD, 780-157, 780-157HD, 780-210, 780-210HD, 780-257HD

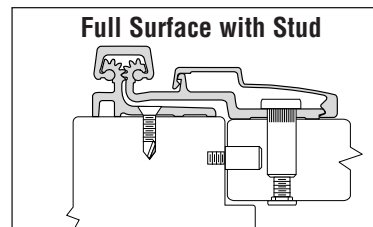
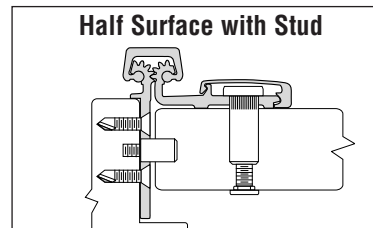
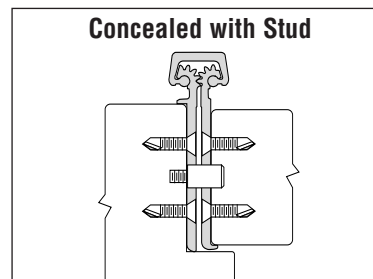

Roton Continuous Geared Hinges



FASTENERS

All hinges are shipped with appropriate fasteners for metal doors and frames. If wood screws are required, please specify on order, and wood screws will be substituted at no extra charge. Bulk screws are packed separately.

Additional fasteners may be ordered as follows —

Add to the hinge list price before applying buying group discount:

| | List | Part # |
|--|---------------------|--|
| #12-14 x 1 1/2" Flat Head Wood Screw (Clear or Bronze) | \$240.00/box of 500 | 7-080-0050 (Clear) 7-080-0051 (Bronze) |
| #12-24 x 1 1/16" Self-Drilling Flat Head Screw (Clear or Bronze) | \$214.00/box of 500 | 7-080-0070 (Clear) 7-080-0072 (Bronze) |
| #12-24 x 1/2" Spanner Head Machine Screw | \$1.80 ea | |
| #12-24 x 1/2" Torx Head Machine Screw | \$1.80 ea | |
| #12-24 x 13/32" Self-Threading Screw (Clear or Bronze) | \$0.70 ea | |
| #12-24 x 1 1/16" Self-Drilling Flat Head Screw (Clear or Bronze) | \$1.05 ea | |
| #12-24 x 1 1/16" Self-Drilling Pan Head Screw (Clear) | \$0.90 ea | |
| #12-14 x 1 1/2" Flat Head Wood Screw (Clear or Bronze) | \$1.05 ea | |
| Sexbolts | \$2.80 ea | |

REPLACEMENT MOLDINGS

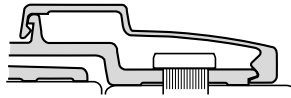

780-210M - Replacement door leaf molding for 780-210, 780-210HD, 780-211, 780-211HD, 780-213, 780-213HD, 780-045, 780-045HD, 780-046, 780-046HD. Furnished with Allen head set screw and wrench. Shipped in stock lengths for trimming in the field.

| | List | List | List |
|----------------------|-------------|---------|---------|
| | 79" 83" 85" | 95" | 119" |
| Clear Anodized | \$41.00 | \$49.50 | \$58.00 |
| Dark Bronze Anodized | \$49.50 | \$58.00 | \$65.50 |

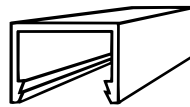
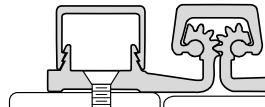

780-247M - Replacement frame leaf molding for 780-157, 780-157HD, 780-257, 780-257HD. Shipped in stock lengths for trimming in the field.

| | List | List | List |
|----------------------|-------------|---------|---------|
| | 79" 83" 85" | 95" | 119" |
| Clear Anodized | \$34.00 | \$41.00 | \$49.50 |
| Dark Bronze Anodized | \$41.00 | \$49.50 | \$58.00 |

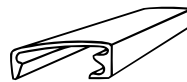
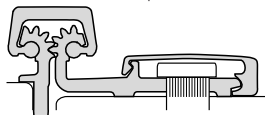

780-052M - Replacement door leaf molding for 780-053, 780-053HD, 780-054, 780-054HD, 780-155, 780-155HD, 780-057, 780-057HD, 780-157, 780-157HD, 780-257, 780-257HD, 780-259, 780-259HD. Furnished with Allen head set screw and wrench. Shipped in stock lengths for trimming in the field.

| | List | List | List |
|----------------------|-------------|---------|---------|
| | 79" 83" 85" | 95" | 119" |
| Clear Anodized | \$38.00 | \$44.00 | \$52.50 |
| Dark Bronze Anodized | \$44.00 | \$52.50 | \$61.00 |



Roton Continuous Geared Hinges

BEARING REPLACEMENT KIT

| | <u>List</u> | <u>List</u> | <u>List</u> |
|----------------------|---------------|-------------|----------------------------------|
| | Standard Duty | Heavy Duty | Extra Heavy Duty for 1200 Series |
| Clear Anodized | \$43.00 | \$82.00 | \$163.00 |
| Dark Bronze Anodized | \$43.00 | \$82.00 | \$163.00 |

SHIPPING CARTONS

Extra shipping cartons are available for reshipping hinges in quantities of 2 or less.

\$22.00 List each

MARKING JIGS

Marking jigs are available to locate the centers of the top end frame screws. These jigs must be ordered at the same time as the hinges to insure fabrication accuracy.

\$202.00 List each

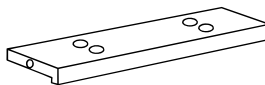

CENTER PUNCHES

Self-Centering center punches are available for #12 countersunk screws supplied. To make sure screw heads seat properly, accurate center punching is required.

\$9.00 List each

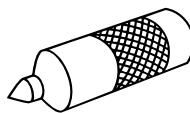

SHIM STOCK

For clearance between the door and frame which may be excessive, a continuous shim is helpful (applied behind the frame leaf only). Anodized aluminum extrusions are supplied with no holes.

| | <u>List</u> |
|--------------------------------|--------------|
| 1/16" x 1 1/2" Wide x 7' Long | \$31.50 each |
| 1/8" x 1 1/2" Wide x 7' Long | \$44.00 each |
| 1/16" x 1 1/2" Wide x 10' Long | \$66.50 each |
| 1/8" x 1 1/2" Wide x 10' Long | \$93.50 each |



Pictures shown in this price book are for general product identification only and are not intended to be used as templates.

Roton Continuous Geared Hinges

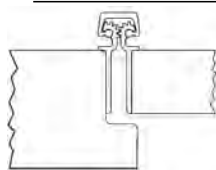

500-048

| DESCRIPTION | SIZE | FINISH | LIST | CASE QTY. |
|---|--------------|-------------|--------|-----------|
| Concealed Leaf 1 1/8" nominal leaf thickness | 24" (610mm) | Clear | 72.15 | 1 |
| | 24" (610mm) | Dark Bronze | 96.20 | 1 |
| | 36" (914mm) | Clear | 84.20 | 1 |
| | 36" (914mm) | Dark Bronze | 108.20 | 1 |
| | 48" (1219mm) | Clear | 96.20 | 1 |
| | 48" (1219mm) | Dark Bronze | 120.25 | 1 |
| | 72" (1829mm) | Clear | 124.35 | 1 |
| | 72" (1829mm) | Dark Bronze | 145.85 | 1 |

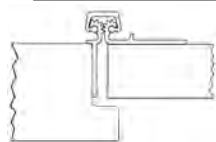

500-200

| DESCRIPTION | SIZE | FINISH | LIST | CASE QTY. |
|---|--------------|-------------|--------|-----------|
| Half Surface 1 1/8" nominal leaf thickness | 24" (610mm) | Clear | 72.15 | 1 |
| | 24" (610mm) | Dark Bronze | 96.20 | 1 |
| | 36" (914mm) | Clear | 84.20 | 1 |
| | 36" (914mm) | Dark Bronze | 108.20 | 1 |
| | 48" (1219mm) | Clear | 96.20 | 1 |
| | 48" (1219mm) | Dark Bronze | 120.25 | 1 |
| | 72" (1829mm) | Clear | 124.35 | 1 |
| | 72" (1829mm) | Dark Bronze | 145.85 | 1 |

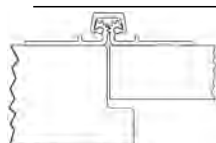

500-220

| DESCRIPTION | SIZE | FINISH | LIST | CASE QTY. |
|---|--------------|-------------|--------|-----------|
| Full Surface 1 1/8" nominal leaf thickness | 24" (610mm) | Clear | 72.15 | 1 |
| | 24" (610mm) | Dark Bronze | 96.20 | 1 |
| | 36" (914mm) | Clear | 84.20 | 1 |
| | 36" (914mm) | Dark Bronze | 108.20 | 1 |
| | 48" (1219mm) | Clear | 96.20 | 1 |
| | 48" (1219mm) | Dark Bronze | 120.25 | 1 |
| | 72" (1829mm) | Clear | 124.35 | 1 |
| | 72" (1829mm) | Dark Bronze | 145.85 | 1 |

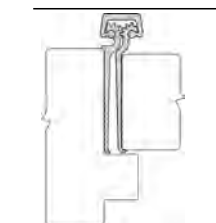

750-134

| DESCRIPTION | SIZE | FINISH | LIST | CASE QTY. |
|---|---------------|-------------|--------|-----------|
| Concealed Leaf 1 3/4" Interior Wood Door | 79" (2007mm) | Clear | 155.55 | 8 |
| | 79" (2007mm) | Dark Bronze | 215.50 | 8 |
| | 83" (2108mm) | Clear | 155.55 | 8 |
| | 83" (2108mm) | Dark Bronze | 215.50 | 8 |
| | 85" (2159mm) | Clear | 155.55 | 8 |
| | 85" (2159mm) | Dark Bronze | 215.50 | 8 |
| | 95" (2413mm) | Clear | 197.80 | 8 |
| | 95" (2413mm) | Dark Bronze | 261.80 | 8 |
| | 119" (3023mm) | Clear | 306.20 | 6 |
| | 119" (3023mm) | Dark Bronze | 391.35 | 6 |

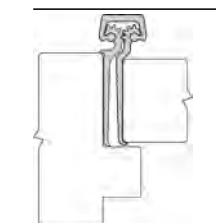

750-138

| DESCRIPTION | SIZE | FINISH | LIST | CASE QTY. |
|---|---------------|-------------|--------|-----------|
| Concealed Leaf 1 3/8" Interior Wood Door | 79" (2007mm) | Clear | 158.25 | 8 |
| | 79" (2007mm) | Dark Bronze | 208.75 | 8 |
| | 83" (2108mm) | Clear | 158.25 | 8 |
| | 83" (2108mm) | Dark Bronze | 208.75 | 8 |
| | 85" (2159mm) | Clear | 158.25 | 8 |
| | 85" (2159mm) | Dark Bronze | 208.75 | 8 |
| | 95" (2413mm) | Clear | 193.65 | 8 |
| | 95" (2413mm) | Dark Bronze | 248.90 | 8 |
| | 119" (3023mm) | Clear | 298.70 | 8 |
| | 119" (3023mm) | Dark Bronze | 374.30 | 8 |



U/M is each unless otherwise noted.
Refer to page 12 for Fire Listings.

1/1/09
800-325-9995
www.hagerco.com



Roton Continuous Geared Hinges

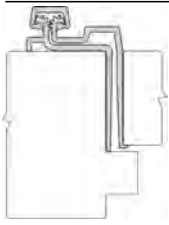

780-041
780-041HD



| DESCRIPTION | SIZE | FINISH | STANDARD | | HEAVY DUTY | |
|----------------------------|---------------|-------------|----------|-----------|------------|-----------|
| | | | LIST | CASE QTY. | LIST | CASE QTY. |
| Concealed Leaf 1¾" Door | 79" (2007mm) | Clear | 252.45 | 6 | 372.25 | 6 |
| | 79" (2007mm) | Dark Bronze | 328.75 | 6 | 489.25 | 6 |
| Swing Clear Action | 83" (2108mm) | Clear | 252.45 | 6 | 372.25 | 6 |
| | 83" (2108mm) | Dark Bronze | 328.75 | 6 | 489.25 | 6 |
| | 85" (2159mm) | Clear | 252.45 | 6 | 372.25 | 6 |
| | 85" (2159mm) | Dark Bronze | 328.75 | 6 | 489.25 | 6 |
| | 95" (2413mm) | Clear | 323.20 | 6 | 456.90 | 6 |
| | 95" (2413mm) | Dark Bronze | 403.40 | 6 | 601.75 | 6 |
| | 119" (3023mm) | Clear | 463.60 | 4 | 682.00 | 2 |
| | 119" (3023mm) | Dark Bronze | 602.90 | 4 | 897.05 | 2 |

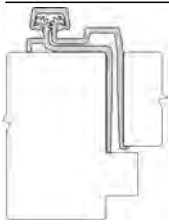

780-041LL



| DESCRIPTION | SIZE | FINISH | LIST | CASE QTY. |
|---|---------------|-------------|--------|-----------|
| Concealed Leaf 1¾" Door | 79" (2007mm) | Clear | 383.40 | 6 |
| | 79" (2007mm) | Dark Bronze | 501.45 | 6 |
| Lead Lined Heavy Duty Profile Only Swing Clear Action | 83" (2108mm) | Clear | 383.40 | 6 |
| | 83" (2108mm) | Dark Bronze | 501.45 | 6 |
| | 85" (2159mm) | Clear | 383.40 | 6 |
| | 85" (2159mm) | Dark Bronze | 501.45 | 6 |
| | 95" (2413mm) | Clear | 469.20 | 6 |
| | 95" (2413mm) | Dark Bronze | 614.05 | 6 |
| | 119" (3023mm) | Clear | 693.10 | 2 |
| | 119" (3023mm) | Dark Bronze | 909.30 | 2 |

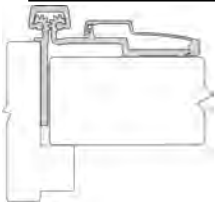

780-045
780-045HD



| DESCRIPTION | SIZE | FINISH | STANDARD | | HEAVY DUTY | |
|--------------|---------------|-------------|----------|-----------|------------|-----------|
| | | | LIST | CASE QTY. | LIST | CASE QTY. |
| Half Surface | 79" (2007mm) | Clear | 351.85 | 4 | 437.05 | 4 |
| | 79" (2007mm) | Dark Bronze | 451.40 | 4 | 584.30 | 4 |
| | 83" (2108mm) | Clear | 351.85 | 4 | 437.05 | 4 |
| | 83" (2108mm) | Dark Bronze | 451.40 | 4 | 584.30 | 4 |
| | 85" (2159mm) | Clear | 351.85 | 4 | 437.05 | 4 |
| | 85" (2159mm) | Dark Bronze | 451.40 | 4 | 584.30 | 4 |
| | 95" (2413mm) | Clear | 433.65 | 4 | 537.30 | 4 |
| | 95" (2413mm) | Dark Bronze | 555.00 | 4 | 718.60 | 4 |
| | 119" (3023mm) | Clear | 645.05 | 2 | 800.45 | 2 |
| | 119" (3023mm) | Dark Bronze | 826.35 | 2 | 1,069.05 | 2 |

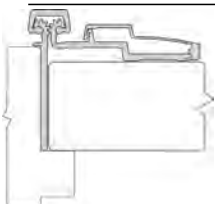

780-046
780-046HD



| DESCRIPTION | SIZE | FINISH | STANDARD | | HEAVY DUTY | |
|--------------|---------------|-------------|----------|-----------|------------|-----------|
| | | | LIST | CASE QTY. | LIST | CASE QTY. |
| Half Surface | 79" (2007mm) | Clear | 379.80 | 4 | 470.45 | 4 |
| | 79" (2007mm) | Dark Bronze | 498.45 | 4 | 617.05 | 4 |
| | 83" (2108mm) | Clear | 379.80 | 4 | 470.45 | 4 |
| | 83" (2108mm) | Dark Bronze | 498.45 | 4 | 617.05 | 4 |
| | 85" (2159mm) | Clear | 379.80 | 4 | 470.45 | 4 |
| | 85" (2159mm) | Dark Bronze | 498.45 | 4 | 617.05 | 4 |
| | 95" (2413mm) | Clear | 467.80 | 4 | 576.85 | 4 |
| | 95" (2413mm) | Dark Bronze | 612.35 | 4 | 767.05 | 4 |
| | 119" (3023mm) | Clear | 696.80 | 2 | 861.75 | 2 |
| | 119" (3023mm) | Dark Bronze | 912.25 | 2 | 1,141.95 | 2 |

U/M is each unless otherwise noted.
Refer to page 12 for Fire Listings.

1/1/09
800-325-9995
www.hagerco.com



Roton Continuous Geared Hinges

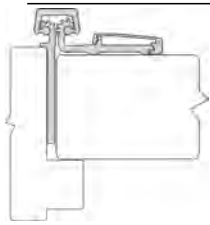

780-053
780-053HD



| DESCRIPTION | SIZE | FINISH | STANDARD | | HEAVY DUTY | |
|---------------|--------------|-------------|----------|-----------|------------|-----------|
| | | | LIST | CASE QTY. | LIST | CASE QTY. |
| Half Surface | 79" (2007mm) | Clear | 240.05 | 5 | 304.15 | 5 |
| | 79" (2007mm) | Dark Bronze | 330.05 | 5 | 377.75 | 5 |
| | 83" (2108mm) | Clear | 240.05 | 5 | 304.15 | 5 |
| | 83" (2108mm) | Dark Bronze | 330.05 | 5 | 377.75 | 5 |
| | 85" (2159mm) | Clear | 240.05 | 5 | 304.15 | 5 |
| | 85" (2159mm) | Dark Bronze | 330.05 | 5 | 377.75 | 5 |
| | 95" (2413mm) | Clear | 297.35 | 5 | 373.70 | 5 |
| | 95" (2413mm) | Dark Bronze | 402.30 | 5 | 452.75 | 5 |
| 119" (3023mm) | Clear | 454.15 | 3 | 572.05 | 3 | |
| | Dark Bronze | 616.30 | 3 | 763.65 | 3 | |

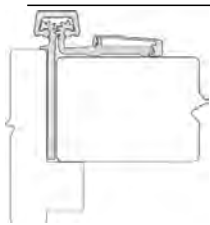

780-054
780-054HD



| DESCRIPTION | SIZE | FINISH | STANDARD | | HEAVY DUTY | |
|---------------|--------------|-------------|----------|-----------|------------|-----------|
| | | | LIST | CASE QTY. | LIST | CASE QTY. |
| Half Surface | 79" (2007mm) | Clear | 253.70 | 5 | 316.40 | 5 |
| | 79" (2007mm) | Dark Bronze | 374.30 | 5 | 385.25 | 5 |
| | 83" (2108mm) | Clear | 253.70 | 5 | 316.40 | 5 |
| | 83" (2108mm) | Dark Bronze | 374.30 | 5 | 385.25 | 5 |
| | 85" (2159mm) | Clear | 253.70 | 5 | 316.40 | 5 |
| | 85" (2159mm) | Dark Bronze | 374.30 | 5 | 385.25 | 5 |
| | 95" (2413mm) | Clear | 312.30 | 5 | 387.35 | 5 |
| | 95" (2413mm) | Dark Bronze | 407.75 | 5 | 458.20 | 5 |
| 119" (3023mm) | Clear | 466.40 | 3 | 595.85 | 3 | |
| | Dark Bronze | 629.30 | 3 | 769.05 | 3 | |

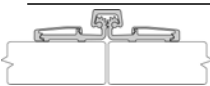

780-057
780-057HD



| DESCRIPTION | SIZE | FINISH | STANDARD | | HEAVY DUTY | |
|--------------------------------------|--------------|-------------|----------|-----------|------------|-----------|
| | | | LIST | CASE QTY. | LIST | CASE QTY. |
| Full Surface Bi-Fold Applications | 79" (2007mm) | Clear | 281.65 | 5 | 338.85 | 5 |
| | 79" (2007mm) | Dark Bronze | 380.55 | 5 | 472.55 | 5 |
| | 83" (2108mm) | Clear | 281.65 | 5 | 338.85 | 5 |
| | 83" (2108mm) | Dark Bronze | 380.55 | 5 | 472.55 | 5 |
| | 85" (2159mm) | Clear | 281.65 | 5 | 338.85 | 5 |
| | 85" (2159mm) | Dark Bronze | 380.55 | 5 | 475.25 | 5 |
| | 95" (2413mm) | Clear | 347.05 | 5 | 425.45 | 5 |
| | 95" (2413mm) | Dark Bronze | 468.40 | 5 | 585.05 | 5 |
| 119" (3023mm) | Clear | 515.50 | 4 | 634.15 | 4 | |
| | Dark Bronze | 698.85 | 4 | 871.35 | 4 | |

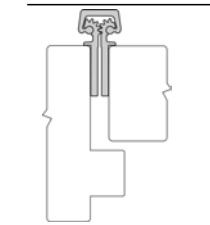

780-110
780-110HD



| DESCRIPTION | SIZE | FINISH | STANDARD | | HEAVY DUTY | |
|----------------|--------------|-------------|----------|-----------|------------|-----------|
| | | | LIST | CASE QTY. | LIST | CASE QTY. |
| Concealed Leaf | 79" (2007mm) | Clear | 171.85 | 8 | 212.75 | 8 |
| | 79" (2007mm) | Dark Bronze | 222.30 | 8 | 274.90 | 8 |
| | 83" (2108mm) | Clear | 171.85 | 8 | 212.75 | 8 |
| | 83" (2108mm) | Dark Bronze | 222.30 | 8 | 274.90 | 8 |
| | 85" (2159mm) | Clear | 171.85 | 8 | 212.75 | 8 |
| | 85" (2159mm) | Dark Bronze | 222.30 | 8 | 274.90 | 8 |
| | 95" (2413mm) | Clear | 207.30 | 8 | 255.75 | 8 |
| | 95" (2413mm) | Dark Bronze | 270.05 | 8 | 331.40 | 8 |
| 119" (3023mm) | Clear | 329.40 | 7 | 405.00 | 7 | |
| | Dark Bronze | 411.85 | 7 | 531.85 | 7 | |



U/M is each unless otherwise noted.
Refer to page 12 for Fire Listings.

1/1/09
800-325-9995
www.hagerco.com



Roton Continuous Geared Hinges

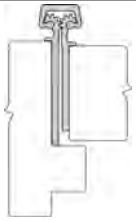

780-111
780-111HD



| DESCRIPTION | SIZE | FINISH | STANDARD | | HEAVY DUTY | |
|----------------|---------------|-------------|----------|-----------|------------|-----------|
| | | | LIST | CASE QTY. | LIST | CASE QTY. |
| Concealed Leaf | 79" (2007mm) | Clear | 167.80 | 8 | 208.75 | 8 |
| | 79" (2007mm) | Dark Bronze | 216.85 | 8 | 270.05 | 8 |
| | 83" (2108mm) | Clear | 167.80 | 8 | 208.75 | 8 |
| | 83" (2108mm) | Dark Bronze | 216.85 | 8 | 270.05 | 8 |
| | 85" (2159mm) | Clear | 167.80 | 8 | 208.75 | 8 |
| | 85" (2159mm) | Dark Bronze | 216.85 | 8 | 270.05 | 8 |
| | 95" (2413mm) | Clear | 202.55 | 8 | 251.00 | 8 |
| | 95" (2413mm) | Dark Bronze | 263.25 | 8 | 324.60 | 8 |
| | 119" (3023mm) | Clear | 321.25 | 7 | 396.85 | 7 |
| | 119" (3023mm) | Dark Bronze | 402.30 | 7 | 522.35 | 7 |

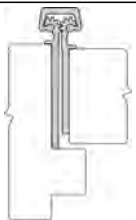

780-111LL



| DESCRIPTION | SIZE | FINISH | LIST | CASE QTY. |
|-------------------------|---------------|-------------|--------|-----------|
| Concealed Leaf | 79" (2007mm) | Clear | 223.70 | 8 |
| Lead Lined | 79" (2007mm) | Dark Bronze | 284.40 | 8 |
| Heavy Duty Profile Only | 83" (2108mm) | Clear | 223.70 | 8 |
| | 83" (2108mm) | Dark Bronze | 284.40 | 8 |
| | 85" (2159mm) | Clear | 223.70 | 8 |
| | 85" (2159mm) | Dark Bronze | 284.40 | 8 |
| | 95" (2413mm) | Clear | 265.95 | 8 |
| | 95" (2413mm) | Dark Bronze | 338.85 | 8 |
| | 119" (3023mm) | Clear | 411.85 | 7 |
| | 119" (3023mm) | Dark Bronze | 537.30 | 7 |



780-112
780-112HD



| DESCRIPTION | SIZE | FINISH | STANDARD | | HEAVY DUTY | |
|----------------|---------------|-------------|----------|-----------|------------|-----------|
| | | | LIST | CASE QTY. | LIST | CASE QTY. |
| Concealed Leaf | 79" (2007mm) | Clear | 148.30 | 8 | 184.25 | 8 |
| | 79" (2007mm) | Dark Bronze | 191.65 | 8 | 238.15 | 8 |
| | 83" (2108mm) | Clear | 148.30 | 8 | 184.25 | 8 |
| | 83" (2108mm) | Dark Bronze | 191.65 | 8 | 238.15 | 8 |
| | 85" (2159mm) | Clear | 148.30 | 8 | 184.25 | 8 |
| | 85" (2159mm) | Dark Bronze | 191.65 | 8 | 238.15 | 8 |
| | 95" (2413mm) | Clear | 181.70 | 8 | 222.05 | 8 |
| | 95" (2413mm) | Dark Bronze | 236.95 | 8 | 292.75 | 8 |
| | 119" (3023mm) | Clear | 290.25 | 7 | 357.20 | 7 |
| | 119" (3023mm) | Dark Bronze | 362.15 | 7 | 470.70 | 7 |



780-112LL



| DESCRIPTION | SIZE | FINISH | LIST | CASE QTY. |
|-------------------------|---------------|-------------|--------|-----------|
| Concealed Leaf | 79" (2007mm) | Clear | 193.55 | 8 |
| Lead Lined | 79" (2007mm) | Dark Bronze | 250.60 | 8 |
| Heavy Duty Profile Only | 83" (2108mm) | Clear | 193.55 | 8 |
| | 83" (2108mm) | Dark Bronze | 250.60 | 8 |
| | 85" (2159mm) | Clear | 193.55 | 8 |
| | 85" (2159mm) | Dark Bronze | 250.60 | 8 |
| | 95" (2413mm) | Clear | 233.20 | 8 |
| | 95" (2413mm) | Dark Bronze | 298.95 | 8 |
| | 119" (3023mm) | Clear | 372.05 | 7 |
| | 119" (3023mm) | Dark Bronze | 486.20 | 7 |

U/M is each unless otherwise noted.
Refer to page 12 for Fire Listings.

1/1/09
800-325-9995
www.hagerco.com



Roton Continuous Geared Hinges

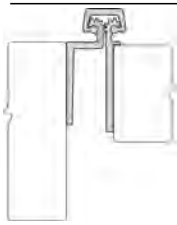

780-113
780-113HD

| DESCRIPTION | SIZE | FINISH | STANDARD | | HEAVY DUTY | |
|---|---------------|-------------|----------|-----------|------------|-----------|
| | | | LIST | CASE QTY. | LIST | CASE QTY. |
| Concealed Leaf "Safety Hinge" When Used Without Frame Stop | 79" (2007mm) | Clear | 210.75 | 6 | 351.85 | 6 |
| | 79" (2007mm) | Dark Bronze | 282.30 | 6 | 473.15 | 6 |
| | 83" (2108mm) | Clear | 210.75 | 6 | 351.85 | 6 |
| | 83" (2108mm) | Dark Bronze | 282.30 | 6 | 473.15 | 6 |
| | 85" (2159mm) | Clear | 210.75 | 6 | 351.85 | 6 |
| | 85" (2159mm) | Dark Bronze | 282.30 | 6 | 473.15 | 6 |
| | 95" (2413mm) | Clear | 259.10 | 6 | 576.85 | 6 |
| | 95" (2413mm) | Dark Bronze | 347.05 | 6 | 647.70 | 6 |
| | 119" (3023mm) | Clear | 387.35 | 4 | 715.90 | 4 |
| | 119" (3023mm) | Dark Bronze | 517.50 | 4 | 846.15 | 4 |

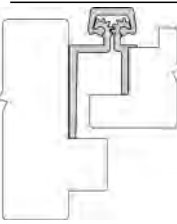

780-114
780-114HD

| DESCRIPTION | SIZE | FINISH | STANDARD | | HEAVY DUTY | |
|---|---------------|-------------|----------|-----------|------------|-----------|
| | | | LIST | CASE QTY. | LIST | CASE QTY. |
| Concealed Leaf Center Hung Applications | 79" (2007mm) | Clear | 222.30 | 5 | 349.10 | 5 |
| | 79" (2007mm) | Dark Bronze | 294.55 | 5 | 462.35 | 5 |
| | 83" (2108mm) | Clear | 222.30 | 5 | 349.10 | 5 |
| | 83" (2108mm) | Dark Bronze | 294.55 | 5 | 462.35 | 5 |
| | 85" (2159mm) | Clear | 222.30 | 5 | 349.10 | 5 |
| | 85" (2159mm) | Dark Bronze | 294.55 | 5 | 462.35 | 5 |
| | 95" (2413mm) | Clear | 272.75 | 5 | 429.60 | 5 |
| | 95" (2413mm) | Dark Bronze | 364.10 | 5 | 567.30 | 5 |
| | 119" (3023mm) | Clear | 405.70 | 3 | 639.60 | 3 |
| | 119" (3023mm) | Dark Bronze | 542.80 | 3 | 845.45 | 3 |

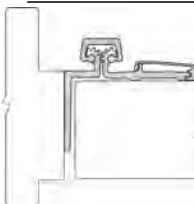

780-155
780-155HD

| DESCRIPTION | SIZE | FINISH | STANDARD | | HEAVY DUTY | |
|---|---------------|-------------|----------|-----------|------------|-----------|
| | | | LIST | CASE QTY. | LIST | CASE QTY. |
| Half Surface Center Hung and Egress Conversions | 79" (2007mm) | Clear | 293.25 | 5 | 369.60 | 5 |
| | 79" (2007mm) | Dark Bronze | 391.35 | 5 | 497.75 | 5 |
| | 83" (2108mm) | Clear | 293.25 | 5 | 369.60 | 5 |
| | 83" (2108mm) | Dark Bronze | 391.35 | 5 | 497.75 | 5 |
| | 85" (2159mm) | Clear | 293.25 | 5 | 369.60 | 5 |
| | 85" (2159mm) | Dark Bronze | 391.35 | 5 | 497.75 | 5 |
| | 95" (2413mm) | Clear | 360.65 | 5 | 453.45 | 5 |
| | 95" (2413mm) | Dark Bronze | 482.05 | 5 | 613.60 | 5 |
| | 119" (3023mm) | Clear | 537.30 | 2 | 675.00 | 2 |
| | 119" (3023mm) | Dark Bronze | 720.00 | 2 | 912.25 | 2 |

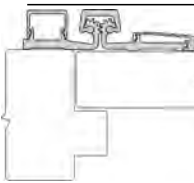

780-157
780-157HD

| DESCRIPTION | SIZE | FINISH | STANDARD | | HEAVY DUTY | |
|---|---------------|-------------|----------|-----------|------------|-----------|
| | | | LIST | CASE QTY. | LIST | CASE QTY. |
| Full Surface Frame Face Dimension Limitations | 79" (2007mm) | Clear | 228.20 | 5 | 282.80 | 5 |
| | 79" (2007mm) | Dark Bronze | 308.25 | 5 | 344.80 | 5 |
| | 83" (2108mm) | Clear | 228.20 | 5 | 282.80 | 5 |
| | 83" (2108mm) | Dark Bronze | 308.25 | 5 | 344.80 | 5 |
| | 85" (2159mm) | Clear | 228.20 | 5 | 282.80 | 5 |
| | 85" (2159mm) | Dark Bronze | 308.25 | 5 | 344.80 | 5 |
| | 95" (2413mm) | Clear | 279.05 | 5 | 339.25 | 5 |
| | 95" (2413mm) | Dark Bronze | 376.45 | 5 | 414.25 | 5 |
| | 119" (3023mm) | Clear | 451.45 | 2 | 556.85 | 2 |
| | 119" (3023mm) | Dark Bronze | 592.80 | 2 | 724.90 | 2 |



U/M is each unless otherwise noted.
Refer to page 12 for Fire Listings.

1/1/09
800-325-9995
www.hagerco.com



Roton Continuous Geared Hinges

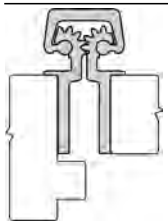

780-208
780-208HD

| DESCRIPTION | SIZE | FINISH | STANDARD | | HEAVY DUTY | |
|--|--------------|-------------|----------|-----------|------------|-----------|
| | | | LIST | CASE QTY. | LIST | CASE QTY. |
| Concealed Leaf Bi-Fold Applications | 79" (2007mm) | Clear | 197.10 | 7 | 253.70 | 7 |
| | 79" (2007mm) | Dark Bronze | 240.05 | 7 | 325.20 | 7 |
| | 83" (2108mm) | Clear | 197.10 | 7 | 253.70 | 7 |
| | 83" (2108mm) | Dark Bronze | 240.05 | 7 | 325.20 | 7 |
| | 85" (2159mm) | Clear | 197.10 | 7 | 253.70 | 7 |
| | 85" (2159mm) | Dark Bronze | 240.05 | 7 | 325.20 | 7 |
| | 95" (2413mm) | Clear | 215.50 | 7 | 278.20 | 7 |
| | 95" (2413mm) | Dark Bronze | 295.90 | 7 | 399.60 | 7 |
| 119" (3023mm) | Clear | 312.30 | 5 | 415.20 | 5 | |
| 119" (3023mm) | Dark Bronze | 440.50 | 5 | 595.85 | 5 | |

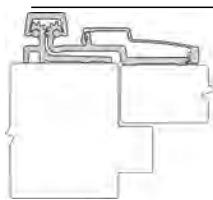

780-210
780-210HD



| DESCRIPTION | SIZE | FINISH | STANDARD | | HEAVY DUTY | |
|---------------|--------------|-------------|----------|-----------|------------|-----------|
| | | | LIST | CASE QTY. | LIST | CASE QTY. |
| Full Surface | 79" (2007mm) | Clear | 228.20 | 6 | 278.50 | 6 |
| | 79" (2007mm) | Dark Bronze | 308.25 | 6 | 338.60 | 6 |
| | 83" (2108mm) | Clear | 228.20 | 6 | 278.50 | 6 |
| | 83" (2108mm) | Dark Bronze | 308.25 | 6 | 338.60 | 6 |
| | 85" (2159mm) | Clear | 228.20 | 6 | 278.50 | 6 |
| | 85" (2159mm) | Dark Bronze | 308.25 | 6 | 338.60 | 6 |
| | 95" (2413mm) | Clear | 274.15 | 6 | 328.70 | 6 |
| | 95" (2413mm) | Dark Bronze | 372.05 | 6 | 404.40 | 6 |
| 119" (3023mm) | Clear | 448.30 | 2 | 544.45 | 2 | |
| 119" (3023mm) | Dark Bronze | 586.60 | 2 | 610.20 | 2 | |

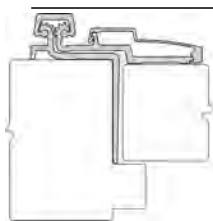

780-211HD



| DESCRIPTION | SIZE | FINISH | LIST | CASE QTY. |
|------------------------|---------------|-------------|----------|-----------|
| Half Surface | 79" (2007mm) | Clear | 516.85 | 4 |
| Frame Leaf Wrap-Around | 79" (2007mm) | Dark Bronze | 679.10 | 4 |
| Reinforcement for | 83" (2108mm) | Clear | 516.85 | 4 |
| Damaged Frames | 83" (2108mm) | Dark Bronze | 679.10 | 4 |
| Heavy Duty | 85" (2159mm) | Clear | 516.85 | 4 |
| | 85" (2159mm) | Dark Bronze | 679.10 | 4 |
| | 95" (2413mm) | Clear | 636.15 | 4 |
| | 95" (2413mm) | Dark Bronze | 835.90 | 4 |
| | 119" (3023mm) | Clear | 947.70 | 2 |
| | 119" (3023mm) | Dark Bronze | 1,245.60 | 2 |

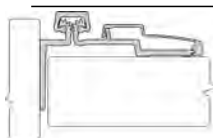

780-213
780-213HD

| DESCRIPTION | SIZE | FINISH | STANDARD | | HEAVY DUTY | |
|-----------------------------------|--------------|-------------|----------|-----------|------------|-----------|
| | | | LIST | CASE QTY. | LIST | CASE QTY. |
| Half Surface Center Hung Doors | 79" (2007mm) | Clear | 329.40 | 4 | 489.60 | 4 |
| | 79" (2007mm) | Dark Bronze | 431.60 | 4 | 646.35 | 4 |
| | 83" (2108mm) | Clear | 329.40 | 4 | 489.60 | 4 |
| | 83" (2108mm) | Dark Bronze | 431.60 | 4 | 646.35 | 4 |
| | 85" (2159mm) | Clear | 329.40 | 4 | 489.60 | 4 |
| | 85" (2159mm) | Dark Bronze | 431.60 | 4 | 646.35 | 4 |
| | 95" (2413mm) | Clear | 405.70 | 4 | 600.70 | 4 |
| | 95" (2413mm) | Dark Bronze | 529.75 | 4 | 795.00 | 4 |
| 119" (3023mm) | Clear | 604.15 | 2 | 895.25 | 2 | |
| 119" (3023mm) | Dark Bronze | 789.55 | 2 | 1,184.90 | 2 | |

U/M is each unless otherwise noted.
Refer to page 12 for Fire Listings.

1/1/09
800-325-9995
www.hagerco.com



Roton Continuous Geared Hinges



| DESCRIPTION | SIZE | FINISH | STANDARD | | HEAVY DUTY | |
|-----------------------------|---------------|-------------|----------|-----------|------------|-----------|
| | | | LIST | CASE QTY. | LIST | CASE QTY. |
| Concealed Leaf 1¾" Doors | 79" (2007mm) | Clear | 150.15 | 7 | 187.35 | 7 |
| | 79" (2007mm) | Dark Bronze | 196.00 | 7 | 243.75 | 7 |
| | 83" (2108mm) | Clear | 150.15 | 7 | 187.35 | 7 |
| | 83" (2108mm) | Dark Bronze | 196.00 | 7 | 243.75 | 7 |
| | 85" (2159mm) | Clear | 150.15 | 7 | 187.35 | 7 |
| | 85" (2159mm) | Dark Bronze | 196.00 | 7 | 243.75 | 7 |
| | 95" (2413mm) | Clear | 188.65 | 7 | 227.00 | 7 |
| | 95" (2413mm) | Dark Bronze | 243.75 | 7 | 298.95 | 7 |
| | 119" (3023mm) | Clear | 297.70 | 5 | 372.05 | 5 |
| | 119" (3023mm) | Dark Bronze | 375.80 | 5 | 484.30 | 5 |

780-224
780-224HD





| DESCRIPTION | SIZE | FINISH | LIST | CASE QTY. |
|---------------------------------------|---------------|-------------|--------|-----------|
| Concealed Leaf 1¾" Doors | 79" (2007mm) | Clear | 204.10 | 7 |
| | 79" (2007mm) | Dark Bronze | 260.50 | 7 |
| Lead Lined Heavy Duty Profile Only | 83" (2108mm) | Clear | 204.10 | 7 |
| | 83" (2108mm) | Dark Bronze | 260.50 | 7 |
| | 85" (2159mm) | Clear | 204.10 | 7 |
| | 85" (2159mm) | Dark Bronze | 260.50 | 7 |
| | 95" (2413mm) | Clear | 246.80 | 7 |
| | 95" (2413mm) | Dark Bronze | 303.85 | 7 |
| | 119" (3023mm) | Clear | 388.20 | 5 |
| | 119" (3023mm) | Dark Bronze | 500.45 | 5 |

780-224LL



| DESCRIPTION | SIZE | FINISH | STANDARD | | HEAVY DUTY | |
|--|---------------|-------------|----------|-----------|------------|-----------|
| | | | LIST | CASE QTY. | LIST | CASE QTY. |
| Concealed Leaf For Doors 2" or Thicker | 79" (2007mm) | Clear | 171.85 | 7 | 213.50 | 7 |
| | 79" (2007mm) | Dark Bronze | 224.40 | 7 | 278.90 | 7 |
| | 83" (2108mm) | Clear | 171.85 | 7 | 213.50 | 7 |
| | 83" (2108mm) | Dark Bronze | 224.40 | 7 | 278.90 | 7 |
| | 85" (2159mm) | Clear | 171.85 | 7 | 213.50 | 7 |
| | 85" (2159mm) | Dark Bronze | 224.40 | 7 | 278.90 | 7 |
| | 95" (2413mm) | Clear | 210.75 | 7 | 259.85 | 7 |
| | 95" (2413mm) | Dark Bronze | 272.75 | 7 | 334.15 | 7 |
| | 119" (3023mm) | Clear | 332.80 | 5 | 417.95 | 5 |
| | 119" (3023mm) | Dark Bronze | 420.65 | 5 | 542.80 | 5 |

780-226
780-226HD



| DESCRIPTION | SIZE | FINISH | LIST | CASE QTY. |
|---|---------------|-------------|--------|-----------|
| Concealed Leaf For Doors 2" or Thicker | 79" (2007mm) | Clear | 229.15 | 7 |
| | 79" (2007mm) | Dark Bronze | 291.85 | 7 |
| Lead Lined Heavy Duty Profile Only | 83" (2108mm) | Clear | 229.15 | 7 |
| | 83" (2108mm) | Dark Bronze | 291.85 | 7 |
| | 85" (2159mm) | Clear | 229.15 | 7 |
| | 85" (2159mm) | Dark Bronze | 291.85 | 7 |
| | 95" (2413mm) | Clear | 276.90 | 7 |
| | 95" (2413mm) | Dark Bronze | 332.80 | 7 |
| | 119" (3023mm) | Clear | 435.05 | 5 |
| | 119" (3023mm) | Dark Bronze | 560.45 | 5 |

780-226LL



U/M is each unless otherwise noted.
Refer to page 12 for Fire Listings.

1/1/09
800-325-9995
www.hagerco.com



Roton Continuous Geared Hinges



780-235HD



| DESCRIPTION | SIZE | FINISH | LIST | CASE QTY. |
|----------------|--------------|-------------|--------|-----------|
| Concealed Leaf | 83" (2108mm) | Clear | 491.65 | 1 |
| Wide Throw | 83" (2108mm) | Dark Bronze | 643.60 | 1 |
| Heavy Duty | 95" (2413mm) | Clear | 606.85 | 1 |
| | 95" (2413mm) | Dark Bronze | 773.15 | 1 |



780-257HD



| DESCRIPTION | SIZE | FINISH | LIST | CASE QTY. |
|---|---------------|-------------|----------|-----------|
| Full Surface | 79" (2007mm) | Clear | 514.10 | 2 |
| Double Hinge for Hanging Two Doors from a Fixed Mullion | 79" (2007mm) | Dark Bronze | 706.35 | 2 |
| | 83" (2108mm) | Clear | 514.10 | 2 |
| Heavy Duty | 83" (2108mm) | Dark Bronze | 706.35 | 2 |
| | 85" (2159mm) | Clear | 514.10 | 2 |
| | 85" (2159mm) | Dark Bronze | 706.35 | 2 |
| | 95" (2413mm) | Clear | 632.70 | 2 |
| | 95" (2413mm) | Dark Bronze | 868.60 | 2 |
| | 119" (3023mm) | Clear | 943.55 | 2 |
| | 119" (3023mm) | Dark Bronze | 1,294.70 | 2 |

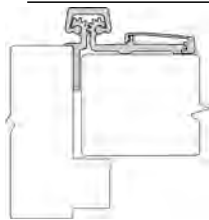

780-259

780-259HD

| DESCRIPTION | SIZE | FINISH | STANDARD | | HEAVY DUTY | |
|------------------------------------|---------------|-------------|----------|-----------|------------|-----------|
| | | | LIST | CASE QTY. | LIST | CASE QTY. |
| Half Surface Millwork Applications | 79" (2007mm) | Clear | 252.30 | 5 | 317.80 | 5 |
| | 79" (2007mm) | Dark Bronze | 344.30 | 5 | 441.85 | 5 |
| | 83" (2108mm) | Clear | 252.30 | 5 | 317.80 | 5 |
| | 83" (2108mm) | Dark Bronze | 343.65 | 5 | 441.85 | 5 |
| | 85" (2159mm) | Clear | 252.30 | 5 | 317.80 | 5 |
| | 85" (2159mm) | Dark Bronze | 344.30 | 5 | 441.85 | 5 |
| | 95" (2413mm) | Clear | 310.30 | 5 | 380.55 | 5 |
| | 95" (2413mm) | Dark Bronze | 422.80 | 5 | 543.40 | 5 |
| | 119" (3023mm) | Clear | 462.35 | 3 | 584.30 | 3 |
| | 119" (3023mm) | Dark Bronze | 629.30 | 3 | 809.30 | 3 |



780-300HD

| DESCRIPTION | SIZE | FINISH | LIST | CASE QTY. |
|--------------------------|---------------|-------------|--------|-----------|
| Half Surface | 79" (2007mm) | Clear | 366.90 | 4 |
| Center Hung Applications | 79" (2007mm) | Dark Bronze | 498.45 | 4 |
| Heavy Duty | 83" (2108mm) | Clear | 366.90 | 4 |
| | 83" (2108mm) | Dark Bronze | 498.45 | 4 |
| | 85" (2159mm) | Clear | 366.90 | 4 |
| | 85" (2159mm) | Dark Bronze | 498.45 | 4 |
| | 95" (2413mm) | Clear | 451.40 | 4 |
| | 95" (2413mm) | Dark Bronze | 612.35 | 4 |
| | 119" (3023mm) | Clear | 672.25 | 2 |
| | 119" (3023mm) | Dark Bronze | 913.60 | 2 |

U/M is each unless otherwise noted.
Refer to page 12 for Fire Listings.

1/1/09
800-325-9995
www.hagerco.com



Roton Continuous Geared Hinges

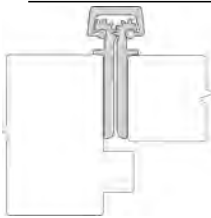

1200-600XHD

| DESCRIPTION | SIZE | FINISH | LIST | CASE QTY. |
|--|---------------|-------------|----------|-----------|
| Concealed Leaf For Doors from 1 $\frac{3}{4}$ " - 2 $\frac{3}{8}$ " Thick Extra Heavy Duty | 83" (2108mm) | Clear | 1,499.90 | 1 |
| | 83" (2108mm) | Dark Bronze | 1,908.95 | 1 |
| | 95" (2413mm) | Clear | 1,636.25 | 1 |
| | 95" (2413mm) | Dark Bronze | 2,045.25 | 1 |
| | 119" (3023mm) | Clear | 1,772.65 | 1 |
| | 119" (3023mm) | Dark Bronze | 2,181.65 | 1 |

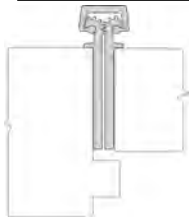

1200-650XHD

| DESCRIPTION | SIZE | FINISH | LIST | CASE QTY. |
|---|---------------|-------------|----------|-----------|
| Concealed Leaf For Doors from 2 $\frac{3}{8}$ " or Thicker Extra Heavy Duty | 83" (2108mm) | Clear | 1,840.75 | 1 |
| | 83" (2108mm) | Dark Bronze | 2,249.85 | 1 |
| | 95" (2413mm) | Clear | 1,977.10 | 1 |
| | 95" (2413mm) | Dark Bronze | 2,386.10 | 1 |
| | 119" (3023mm) | Clear | 2,113.50 | 1 |
| | 119" (3023mm) | Dark Bronze | 2,522.50 | 1 |



U/M is each unless otherwise noted.
Refer to page 12 for Fire Listings.

1/1/09
800-325-9995
www.hagerco.com