



Table of Contents

A			
Accessories, 4500 Series Grade 1		Strikes, 4500 Series Grade 1	
Bottom Latch Assembly	6	Fire Rated, Rim Device	5
Cylinder Dogging Conversion Kit	6	Surface Vertical Rod, Bottom Strike, Fire Rated	6
Replacement Head Covers	7	Surface Vertical Rod, Top Strike, Fire Rated	6
Top Latch Assembly	7	Standard, Rim Device	5
Top Rod Replacement Kit	7	Surface Vertical Rod, Bottom Strike	6
Accessories, 4700 Series Standard Duty		Surface Vertical Rod, Top Strike	6
Bottom Latch Assembly	10	Threshold Strike	10
Replacement Dogging Plates	11	Strikes, 4700 Series Standard Duty	
Replacement Head Covers	11	Double Door Strike	10
Top Latch Assembly	10	Fire Rated with Mullion	10
Top Rod Replacement Kit	10	Rim Device	10
		Surface Vertical Rod, Bottom Strike	10
C		Surface Vertical Rod, Top Strike	10
Cylinders		Threshold Strike	10
Mortise	12		
Rim	12	T	
Cores		Trim, 4500 Series Grade 1	
Interchangeable	12	Blank Escutcheon	5
Standard	12	Cylinder Escutcheon	5
		Dummy Trim	5
E		Night Latch	5
Exit Devices, Grade 1		Pull Plate Trim	5
4500 Series Rim Device	4	Trim, 4700 Series Standard Duty	
4500 Surface Vertical Rod Device	4	Blank Escutcheon	8
Exit Devices, Standard Duty		Cylinder Escutcheon	8
4700 Series Rim Device	8	Dummy Trim	8
4700 Surface Vertical Rod Device	8	Key-In-Lever Trim	9
		Night Latch	8
M		Pull Plate Trim	9
Mullions		Raised Lip – Dummy	9
Mullion Set	12	Raised Lip – Night Latch	9
Mullion Tube	12		
Top/Bottom Bracket Set	12		
		S	
S		Shim Kit, 4500 Series Grade 1	
Shim Kit, 4500 Series Grade 1		Shim Kit, Rim Device	7
Shim Kit, Rim Device	7	Shim Kit, Surface Vertical Rod	7
Shim Kit, Surface Vertical Rod	7	Shim Kit, 4700 Series Standard Duty	
Shim Kit, 4700 Series Standard Duty		Shim Kit, Rim Device	11
Shim Kit, Rim Device	11	Shim Kit, Surface Vertical Rod	11
Shim Kit, Surface Vertical Rod	11		



Exit Devices

General Information

INTRODUCTION

The Hager 4500 Series Exit Devices meet Life Safety codes and Fire Safety requirements providing a perfect fit for use in commercial office buildings, medical and educational facilities, as well as hospitality structures.

The 4500 Series is BHMA-Certified to the requirements of ANSI 156.3 for Grade 1 Exit Devices and is UL 305 Panic listed and UL and cUL listed for up to 3 hours for both Rim and Surface Vertical Rod.

These devices have also met the requirements of ANSI A250.13 to be listed as a Severe Windstorm Component.

The 4500 Exit Device offers a Lifetime Warranty to provide peace-of-mind from the distributors the building owner.

Applications

Single Door with Rim Exit Device

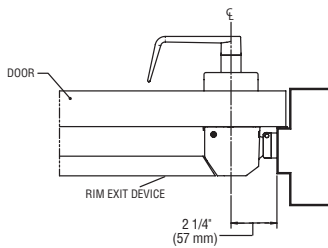

Double Door with Surface Vertical Rod Exit Device

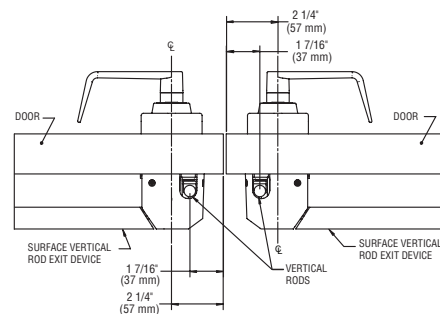

Double Door with Rim Exit Device and Surface Vertical Rod Exit Device

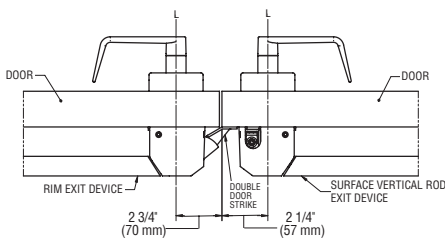

Double Door with Mullion

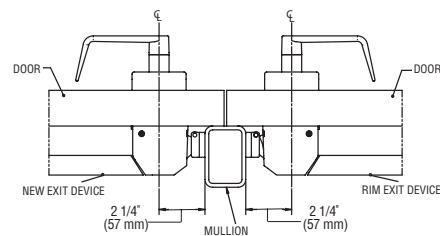



Electric Modifications

Electric Latch Retraction	ELR	Provides a remote mean of locking or unlocking exit devices	\$799.00
Electric Dogging	ED	Provides continuous latch retraction and dogging simultaneously	\$619.00
Request to Exit	RX	Used to shunt an alarm, activate an alarm, provide release of magnetic locks, or signal a console	\$299.00
Electric Trim	ET	Provides a remote means of locking or unlocking outside lever trim controls	\$459.00
Electric Latch Retraction With Request to Exit	ELRX	Provides a remote mean of locking or unlocking exit devices along with an SPDT switch	\$889.00
Electric Dogging with Request to Exit	EDRX	Provides continuous latch retraction and dogging simultaneously along with an SPDT switch	\$709.00

*Add the above electric modification charges to the list price of the exit device.

How to Order

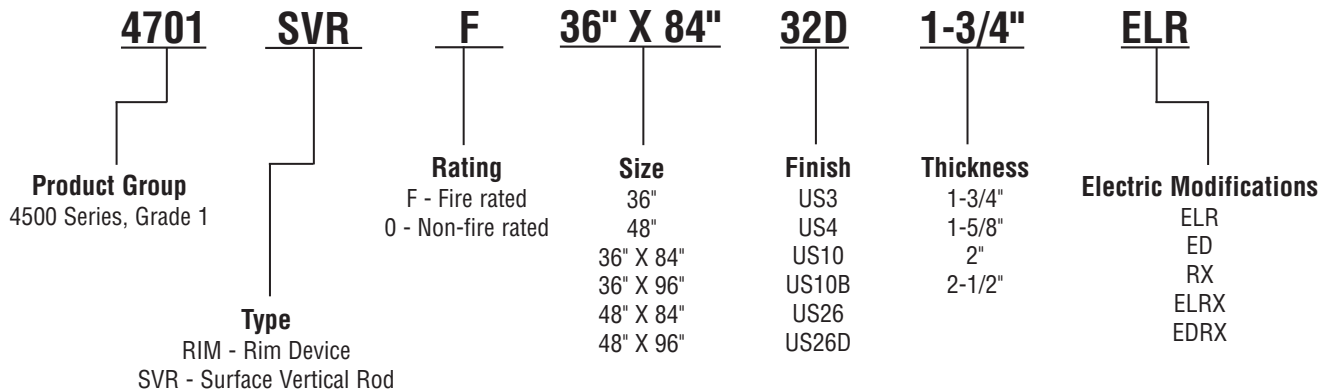



Exit Devices



4500 Series

DESCRIPTION	LENGTH	FINISH	LIST	LIST FIRE RATED	CASE QTY.
4500 Series	36"	US3	664.00	758.00	3
Rim	Exit Only	US4	664.00	758.00	3
Grade 1		US10	664.00	758.00	3
Non-Handed		US10B	664.00	758.00	3
		US26	664.00	758.00	3
		US26D	641.00	734.00	3
		US32D	664.00	758.00	3
	48"	US3	687.00	787.00	3
	Exit Only	US4	687.00	787.00	3
		US10	687.00	787.00	3
		US10B	687.00	787.00	3
		US26	687.00	787.00	3
		US26D	670.00	763.00	3
		US32D	687.00	787.00	3

Note: Cylinder Dogging: \$30.00, cylinder must be ordered separately
Severe Windstorm Rated device: add \$40.00 to list price

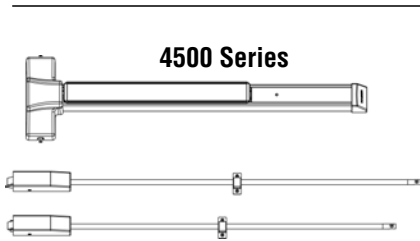

4500 Series

DESCRIPTION	LENGTH	FINISH	LIST	LIST FIRE RATED	CASE QTY.
4500 Series	36"x84"	US3	979.00	1060.00	3
Surface Vertical Rod	Exit Only	US4	979.00	1060.00	3
Grade 1		US10	979.00	1060.00	3
Non-Handed		US10B	979.00	1060.00	3
		US26	979.00	1060.00	3
		US26D	903.00	991.00	3
		US32D	979.00	1060.00	3
	36"x96"	US3	1015.00	1108.00	3
	Exit Only	US4	1015.00	1108.00	3
		US10	1015.00	1108.00	3
		US10B	1015.00	1108.00	3
		US26	1015.00	1108.00	3
		US26D	962.00	1049.00	3
		US32D	1015.00	1108.00	3
	48"x84"	US3	1049.00	1137.00	3
	Exit Only	US4	1049.00	1137.00	3
		US10	1049.00	1137.00	3
		US10B	1049.00	1137.00	3
		US26	1049.00	1137.00	3
		US26D	991.00	1072.00	3
		US32D	1049.00	1137.00	3
	48"x96"	US3	1067.00	1154.00	3
	Exit Only	US4	1067.00	1154.00	3
		US10	1067.00	1154.00	3
		US10B	1067.00	1154.00	3
		US26	1067.00	1154.00	3
		US26D	1049.00	1108.00	3
		US32D	1067.00	1154.00	3





Note: Cylinder Dogging: \$30.00, cylinder must be ordered separately
Severe Windstorm Rated device: add \$40.00 to list price

U/M is each unless otherwise noted.

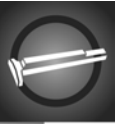



Exit Devices



4500 SERIES TRIM OPTIONS					
	DESCRIPTION	FUNCTION	FINISH	LIST	CASE QTY.
45BE 	Blank Escutcheon	14 Always Operable	US3	338.00	6
			US4	338.00	6
			US10	338.00	6
			US10B	338.00	6
			US26	338.00	6
			US26D	326.00	6
45CE 	Cylinder Escutcheon Requires the use of a Mortise Cylinder with standard cam	08 Key Locks or Unlocks Lever	US3	338.00	6
			US4	338.00	6
			US10	338.00	6
			US10B	338.00	6
			US26	338.00	6
			US26D	326.00	6
45DT 	Dummy Trim	02 Pull When Device is Dogged Down	US3	338.00	6
			US4	338.00	6
			US10	338.00	6
			US10B	338.00	6
			US26	338.00	6
			US26D	326.00	6
45NL 	Night Latch Requires the use of a Rim Cylinder with a long tailpiece	03 Key Retracts Latchbolt	US3	338.00	6
			US4	338.00	6
			US10	338.00	6
			US10B	338.00	6
			US26	338.00	6
			US26D	326.00	6

Notes: Cylinders sold separately: Order 3901 for NL function, 3902 for CE function
Archer, August and Withnell levers available

45PD 	Pull Plate Dummy Trim	02 Pull When Device is Dogged Down	US3	91.00	12
			US4	91.00	12
			US10	91.00	12
			US10B	91.00	12
			US26	91.00	12
			US26D	91.00	12
45PN 	Pull Plate Night Latch Requires the use of a Rim Cylinder	03 Key Retracts Latch Bolt	US3	102.00	12
			US4	102.00	12
			US10	102.00	12
			US10B	102.00	12
			US26	102.00	12
			US26D	102.00	12
US32D	102.00	12			

Notes: Cylinders sold separately: Order 3901

4500 SERIES STRIKES				
	DESCRIPTION	FINISH	LIST	CASE QTY.
4920 	Strike for use with 4500 Rim Exit Device	US32D	46.00	24
4920F 	Fire rated strike for use with 4500 Rim Exit Device	US32D	64.00	24







U/M is each unless otherwise noted.

1/1/09
800-325-9995
www.hagerco.com

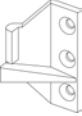

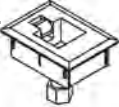
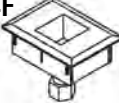
Exit Devices







4500 SERIES STRIKES (CONTINUED)				
	DESCRIPTION	FINISH	LIST	CASE QTY.
4921 	Double Door Strikes for 4500 Surface Vertical Rod and Rim Exit Device	US3	46.00	24
		US4	46.00	24
		US10	46.00	24
		US10B	46.00	24
		US26	46.00	24
		US32D	46.00	24
4923 	Top strike for use with 4500 Surface Vertical Rod Device	US32D	29.00	24
4923F 	Fire rated top strike for use with 4500 Surface Vertical Rod Device	US32D	35.00	24
4924 	Bottom strike for use with 4500 Surface Vertical Rod Device	US32D	29.00	12
4924F 	Fire rated bottom strike for use with 4500 Surface Vertical Rod Device	US32D	38.00	12

4500 SERIES ACCESSORIES					
	DESCRIPTION	LENGTH	FINISH	LIST	CASE QTY.
4926 	Cylinder Dogging Conversion Kit - Panic Rated Requires the use of a Mortise Cylinder with standard cam Note: Cylinder sold separately	36"	US3	30.00	48
		36"	US4	30.00	48
		36"	US10	30.00	48
		36"	US10B	30.00	48
		36"	US26	30.00	48
		36"	US26D	30.00	48
		36"	US32D	30.00	48
		48"	US3	32.00	36
		48"	US4	32.00	36
		48"	US10	32.00	36
		48"	US10B	32.00	36
		48"	US26	32.00	36
		48"	US26D	32.00	36
		48"	US32D	32.00	36
4927 	Bottom Latch Assembly Includes latch, cover and screws		US3	64.00	24
			US4	64.00	24
			US10	64.00	24
			US10B	64.00	24
			US26	64.00	24
			US26D	64.00	24
			US32D	64.00	24

U/M is each unless otherwise noted.



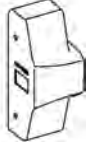

4500 SERIES ACCESSORIES (CONTINUED)					
	DESCRIPTION	LENGTH	FINISH	LIST	CASE QTY.
4928 	Top Latch Assembly Includes latch, cover and screws		US3	64.00	24
			US4	64.00	24
			US10	64.00	24
			US10B	64.00	24
			US26	64.00	24
			US26D	64.00	24
			US32D	64.00	24
4929 	Top Rod Replacement Kit Includes rod, rod guide, rod connector assembly and all appropriate screws		US3	30.00	24
			US4	30.00	24
			US10	30.00	24
			US10B	30.00	24
			US26	30.00	24
			US26D	30.00	24
			US32D	30.00	24
4930R 	Shim Kit for 4500 Rim Device Packaged 2 ea. 1/8" shims		US3	54.00	24
			US4	54.00	24
			US10	54.00	24
			US10B	54.00	24
			US26	54.00	24
			US26D	54.00	24
			US32D	64.00	24
4930S 	Shim Kit for 4500 Surface Vertical Rod Device Packaged 2 ea. 1/8" shims		US3	54.00	24
			US4	54.00	24
			US10	54.00	24
			US10B	54.00	24
			US26	54.00	24
			US26D	54.00	24
			US32D	64.00	24
4932R 	Replacement Head Cover for Rim Device		US3	54.00	20
			US4	54.00	20
			US10	54.00	20
			US10B	54.00	20
			US26	54.00	20
			US26D	54.00	20
			US32D	64.00	20
4932S 	Replacement Head Cover for SVR Device		US3	54.00	20
			US4	54.00	20
			US10	54.00	20
			US10B	54.00	20
			US26	54.00	20
			US26D	54.00	20
			US32D	64.00	20





U/M is each unless otherwise noted.





1/1/09
 800-325-9995
 www.hagerco.com



Exit Devices

	DESCRIPTION	LENGTH	FINISH	LIST	LIST FIRE RATED	CASE QTY.
 <p>4700 Series</p>	4700 Series Rim	36" Exit Only	ALM	211.00	290.00	3
	Standard Duty Non-Handed		DBZ	211.00	290.00	3
			US3	356.00	437.00	3
			US32D	356.00	437.00	3
		48" Exit Only	ALM	237.00	317.00	3
	DBZ		237.00	317.00	3	
	US3		383.00	463.00	3	
	US32D		383.00	463.00	3	

	DESCRIPTION	LENGTH	FINISH	LIST	LIST FIRE RATED	CASE QTY.
 <p>4700 Series</p>	4700 Series Surface Vertical Rod Standard Duty Non-Handed	36"x84" Exit Only	ALM	343.00	475.00	3
			DBZ	343.00	475.00	3
			US3	489.00	621.00	3
			US32D	489.00	621.00	3
	36"x96" Exit Only	ALM	370.00	502.00	3	
		DBZ	370.00	502.00	3	
		US3	515.00	648.00	3	
		US32D	515.00	648.00	3	
	48"x84" Exit Only	ALM	383.00	515.00	3	
		DBZ	383.00	515.00	3	
		US3	518.00	660.00	3	
		US32D	518.00	660.00	3	
	48"x96" Exit Only	ALM	396.00	529.00	3	
		DBZ	396.00	529.00	3	
		US3	542.00	675.00	3	
		US32D	542.00	675.00	3	

4700 SERIES TRIM OPTIONS					
	DESCRIPTION	FUNCTION	FINISH	LIST	CASE QTY.
 <p>47BE</p>	Blank Escutcheon	14 Always Operable	ALM	167.00	6
			DBZ	167.00	6
			US3	183.00	6
			US32D	183.00	6
 <p>47CE</p>	Cylinder Escutcheon Requires the use of a Mortise Cylinder with standard cam	08 Key Locks or Unlocks Lever	ALM	167.00	6
			DBZ	167.00	6
			US3	183.00	6
			US32D	183.00	6
 <p>47DT</p>	Dummy Trim	02 Pull When Device is Dogged Down	ALM	167.00	6
			DBZ	167.00	6
			US3	183.00	6
			US32D	183.00	6
 <p>47NL</p>	Night Latch Requires the use of a Mortise Cylinder with standard cam	03 Key Retracts Latchbolt	ALM	167.00	6
			DBZ	167.00	6
			US3	183.00	6
			US32D	183.00	6

Notes: Must specify handing on all escutcheon trim when ordering







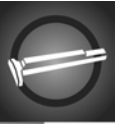

Cylinders sold separately: Order 3902

Archer, August and Withnell levers available

U/M is each unless otherwise noted.





4700 SERIES TRIM OPTIONS (CONTINUED)					
	DESCRIPTION	FUNCTION	FINISH	LIST	CASE QTY.
47KD 	Dummy Trim	02 Entrance by trim when actuating bar is locked down	ALM	151.00	12
			DBZ	151.00	12
			US3	167.00	12
			US32D	167.00	12
47KE 	Entrance Standard Core and Small Format Interchangeable Core available Note: SFIC sold separately	08 Entrance by lever Key locks or unlocks lever	ALM	167.00	12
			DBZ	167.00	12
			US3	183.00	12
			US32D	183.00	12
47KN 	Night Latch Standard Core and Small Format Interchangeable Core available Note: SFIC sold separately	03 Entrance by trim when latch bolt is released by key. Key removable only when locked.	ALM	167.00	12
			DBZ	167.00	12
			US3	183.00	12
			US32D	183.00	12
47KP 	Passage	14 Entrance by trim when latch bolt is released by lever. Always active, no cylinder.	ALM	151.00	12
			DBZ	151.00	12
			US3	167.00	12
			US32D	167.00	12
47PD 	Pull Plate Dummy Trim	02 Pull When Device is Dogged Down	ALM	75.00	12
			DBZ	75.00	12
			US3	75.00	12
			US32D	75.00	12
47PN 	Pull Plate Night Latch Requires the use of a Rim Cylinder	03 Key Retracts Latchbolt	ALM	86.00	12
			DBZ	86.00	12
			US3	86.00	12
			US32D	86.00	12
Cylinders sold separately: Order 3901					
47RD 	Raised Lip Pull Dummy Trim	02 Pull When Device is Dogged Down	ALM	41.00	6
			DBZ	41.00	6
			US3	41.00	6
			US32D	41.00	6
47RN 	Raised Lip Pull Night Latch Requires the use of a Rim Cylinder	03 Key Retracts Latchbolt	ALM	46.00	6
			DBZ	46.00	6
			US3	46.00	6
			US32D	46.00	6
Cylinders sold separately: Order 3901					









U/M is each unless otherwise noted.

1/1/09
800-325-9995
www.hagerco.com

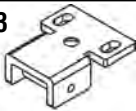
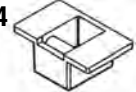
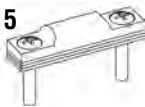

Exit Devices







4700 SERIES STRIKES				
	DESCRIPTION	FINISH	LIST	CASE QTY.
4910	 Strike for use with 4700 Rim Exit Device	US32D	46.00	24
4911	 Double door strike for 4700 Surface Vertical Rod and Rim Exit Device	DBZ US3 US32D	41.00 41.00 41.00	24 24 24
4913	 Top strike for 4700 Surface Vertical Rod Exit Device	US32D	29.00	24
4914	 Bottom strike for 4700 Surface Vertical Rod Exit Device	US32D	29.00	24
4915	 Threshold Strike for use with 4500 Series or 4700 Series	US32D	16.00	48

4700 SERIES ACCESSORIES				
	DESCRIPTION	FINISH	LIST	CASE QTY.
4917	 Bottom Latch Assembly Includes latch, cover and screws	ALM DBZ US3 US32D	43.00 43.00 43.00 43.00	50 50 50 50
4918	 Top Latch Assembly Includes latch, cover and screws	ALM DBZ US3 US32D	43.00 43.00 43.00 43.00	50 50 50 50
4919	 Top Rod Replacement Kit Includes rod, rod guide, rod connector assembly and all appropriate screws	ALM DBZ US3 US32D	21.00 21.00 21.00 21.00	24 24 24 24

U/M is each unless otherwise noted.





4700 SERIES ACCESSORIES (CONTINUED)					
	DESCRIPTION	FINISH	LIST	CASE QTY.	
4931R 	Shim Kit for 4700 Rim Device Packaged 2 ea. 1/8" shims	ALM	37.00	24	
		DBZ	37.00	24	
		US3	43.00	24	
		US32D	43.00	24	
4931S 	Shim Kit for 4700 Surface Vertical Rod Device Packaged 2 ea. 1/8" shims	ALM	37.00	24	
		DBZ	37.00	24	
		US3	43.00	24	
		US32D	43.00	24	
4933R 	Replacement Head Cover for Rim Device	ALM	27.00	20	
		DBZ	27.00	20	
		US3	32.00	20	
		US32D	32.00	20	
4933S 	Replacement Head Cover for SVR Device	ALM	27.00	20	
		DBZ	27.00	20	
		US3	32.00	20	
		US32D	32.00	20	
4934 	Replacement Dogging Plate - Panic Rated Device	36"	ALM	21.00	20
		36"	DBZ	21.00	20
		36"	US3	21.00	20
		36"	US32D	21.00	20
		48"	ALM	24.00	20
		48"	DBZ	24.00	20
		48"	US3	24.00	20
		48"	US32D	24.00	20
4934F 	Replacement Dogging Plate - Fire Rated Device	36"	ALM	21.00	20
		36"	DBZ	21.00	20
		36"	US3	21.00	20
		36"	US32D	21.00	20
		48"	ALM	24.00	20
		48"	DBZ	24.00	20
		48"	US3	24.00	20
		48"	US32D	24.00	20







U/M is each unless otherwise noted.

1/1/09
 800-325-9995
 www.hagerco.com



Exit Devices

4700 SERIES MULLIONS						
	DESCRIPTION	LENGTH	FINISH	LIST	LIST FIRE RATED	CASE QTY.
4900	 Series Mullion Set* Key Removable 11 Gauge Steel Tube Top Bracket/Bottom Bracket Set	7'	USP	758.00	816.00	1
		8'	USP	758.00	816.00	1
		10'	USP	874.00		1
4902	 Top/Bottom Bracket Set* Key Removable Non Fire-Rated		USP	466.00	524.00	5
4907	 Mullion Tube 11 Gauge Steel	7'	USP	314.00		1
		8'	USP	314.00		1
		10'	USP	408.00		1
Note: *Cylinders sold separately: Order 3901						
4912	 Fire rated strike for use with 4500 Series Exit Device and Mullion		US32D	91.00		24
4916	 Fire rated strike for use with 4700 Series Exit Device and Mullion			91.00		24

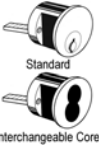
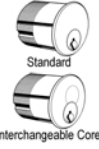
CYLINDERS				
	DESCRIPTION	FINISH	LIST	BOX QTY.
3901	 Rim Cylinder Standard Core and Small Format Interchangeable Core available Shipped standard with long break-off tailpiece	US3	35.80	1
		US4	38.10	1
		US10	38.10	1
		US10B	35.80	1
		US26	35.80	1
		US26D	35.80	1
3902	 Mortise Cylinder** Standard Core and Small Format Interchangeable Core available Shipped standard with standard cam attached and Adams Rite cam loose in box ** Specify 1½" or 1¼" length and cam required	US3	35.80	1
		US4	38.10	1
		US10	38.10	1
		US10B	35.80	1
		US26	35.80	1
		US26D	35.80	1

*Interchangeable Cores sold separately, specify 6-pin or 7-pin and required cam
 Note: Interchangeable core housings only available in US3, US4, US10B and US26D
 For more information on SFIC, please refer to Locks section.

U/M is each unless otherwise noted.

1/1/09
 800-325-9995
 www.hagerco.com

